

Polaroid



Operating Instructions

P32RDP0112U Smart HD TV / DVD Combi

User Manual

Image for illustration purposes only. Actual product may vary.

PAGE LEFT INTENTIONALLY BLANK

PAGE LEFT INTENTIONALLY BLANK

IMPORTANT GUARANTEE INFORMATION

Thank you for purchasing this television. We hope you have many years of trouble free enjoyment from your purchase.

Your product is covered under the manufacturers' guarantee for 12 months from the date of purchase.

If you experience any difficulties with your TV, please refer to the 'Frequently asked questions' section at the rear of these Operating Instructions.

If you are still unable to remedy the issue, try resetting the TV to factory settings - details can be found in the 'Settings' menu section of these Operating Instructions - alternatively, please contact the helpline.

Technical Support Information

Telephone: 0333 600 7700

Web: www.asda.com

Calls to 0333 numbers are charged at standard call rates and are included as part of any bundled minutes with your phone provider.



ASDA
technical support
0333 600 7700

We're open Monday to Saturday from 9am until 6pm and Sundays between 10am and 4pm.

Please retain all packaging materials, in addition to your proof of purchase/receipt, as you will need these in the event of warranty/service support.

This guarantee is in addition to and does not affect your statutory rights.

If you need to call the helpline, you will need the following information.

- 1) Model No _____ (You can find this on the rear of the TV)
- 2) Date of purchase _____ (You can find this on your sales receipt)
- 3) Serial Number _____ (You can find this on the rear of the TV)

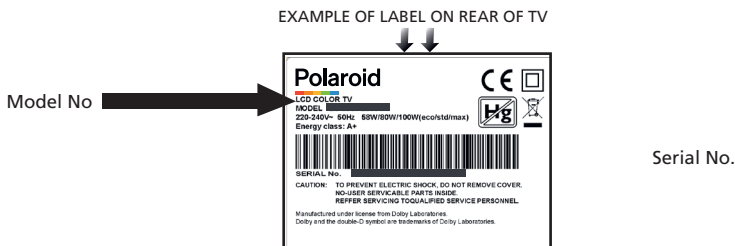

This TV set is for domestic use only

Important Safety Instructions

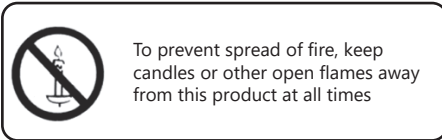

Please read these instructions. All of the safety and operating instructions should be read before the appliance is operated.

~ - Alternating current

- This equipment is a Class II or double insulated electrical appliance. It has been designed in such a way that it does not require a safety connection to electrical earth.

Warnings

- Television sets with 40" screens or larger must be lifted and carried by at least 2 people.
- This television does not contain any parts that are serviceable by the user. In the event of a fault, contact the manufacturer or authorised service department.
- Exposing the internal parts of the TV may endanger your life. The manufacturer's guarantee does not extend to faults caused by repairs carried out by unauthorised third parties.
- Do not use the TV set immediately after unpacking. Wait until the TV warms up to room temperature before using it.
- To reduce the risk of fire, electric shock or damage to the TV, do not expose it to dust, rain or moisture. Never expose the TV to dripping or splashing and do not place objects filled with liquids on or near the TV.
- Do not connect any external devices (DVD player, games console etc.) when the TV is switched on. Disconnect both the TV and device from the mains before connecting. Only switch appliances on when the connection process is complete.
- Do not place the television in a confined space and do not obstruct the ventilation openings at the rear of the television.
- When installing on a wall, ensure the TV is at least 5cm from the wall for ventilation.
- Always ensure that the TV's ventilation openings are not covered with items such as newspapers, table-cloths, curtains, etc.
- Dispose of this television and any components including batteries in an environmentally friendly manner. If in doubt, please contact your local authority for details of recycling.
- Ensure this TV is used in moderate climates only.
- In cases of electrostatic discharge (ESD) the TV may operate incorrectly. If this happens, turn the set off at the mains and then turn back on again after 30 seconds. The set should now work normally.
- TV operating Conditions:
 - Temperature from +10°C to + 35°C
 - Humidity no more than 80% (at a temperature of 25°C)

WARNING: Never place a television set on an unstable surface. The TV set may fall causing serious personal injury or death. Many injuries, particularly to children, can be avoided by taking simple precautions such as:

- Use cabinets or stands recommended by the manufacturer of the television set.
- Only use furniture that can safely support the television set.
- Ensure the television set is not overhanging the edge of the supporting furniture.
- Do not place the television set on tall furniture (for example, cupboards or bookcases) without anchoring both the furniture and the television set to a suitable support.
- Do not place the television set on cloth or other materials that may be located between the television set and supporting furniture.
- For maximum safety while using your set, it is recommended to fit anti-tip straps. These are designed to be attached between the wall/secure surface and the VESA mounts on the television. These are available from major retailers and websites and are an easy and inexpensive way of ensuring that your set stays safely upright.
- Please educate children about the dangers of climbing on furniture to reach the television set or its controls.
- If your existing television set is being retained and relocated, the same considerations as above should be applied.

Safety

- For your safety, this appliance is fitted with a fused 3 pin mains plug. Should the fuse need to be replaced, ensure that any replacement is of the same amperage and approved with the BSI mark.
- Never try and replace the mains plug unless you have adequate qualifications and are legally authorised to do so. In the event that a replacement mains cable is required, contact the manufacturer for a suitable replacement.
- Never use the television if it is damaged in any way.
- Always place the television on a flat level surface avoiding anywhere which may be subject to strong vibration.
- The ideal distance to watch the television is from approximately 2.5-3 times the length of the diagonal measurements of the TV screen away.
- Ensure the television is not placed on top of the power cable as the weight of the television may damage the cable and cause a safety hazard.
- Never place mobile phones, speakers or any other device which may cause magnetic or radio interference, near the television. If interference is apparent, move the device causing the interference away from the television.
- To disconnect the set from the mains, remove the mains plug from the socket.
- Ensure that the mains plug is always easily accessible.
- When handling the set do not grip the LCD screen/glass.
- Do not pull the set when mounted on a bracket. If using a moveable bracket, adjust via the bracket and not the TV set.
- Do not place this set above a heat source.

WARNING: Excessive volume when using earphones and headphones can cause damage to hearing.

Important Safety Instructions



Maintenance

- To clean your TV, wipe with a soft, dry cloth. If the surfaces are extremely dirty, use a soft cloth dampened with a weak detergent solution.
- Never use alcohol, paint thinner or benzene to clean this unit.
- Before using a chemically treated cloth, read the instructions that came with the cloth carefully.

CAUTION: If water or other liquid enters the television through the display panel surface, a malfunction may occur.



Packaging

- The safest way to transport your item is in the original box/packaging - please save your packaging for this.
- You will need the original box/packaging in the event of warranty/service repair or support. We are unable to carry out warranty/service if you are unable to package the item correctly.

Important information regarding use of video games, computers, captions or other fixed image displays

The extended use of fixed image program material can cause a permanent "shadow image" on the LCD/LED panel, also known as "screen burn".

This "shadow image" can appear in the background during normal viewing. This type of irreversible LCD/LED panel deterioration can be limited by observing the following steps:

1. Reduce the brightness/contrast setting to a minimum suitable viewing level.
2. Do not display the fixed image for extended periods of time.
3. Turn the power off when not in use.

Examples of images that are more likely to cause "screen burn" are as follows (this is not an exhaustive list):

- TV channel logos: e.g. shopping channel logos and pricing displays - especially if they are bright and stationary. Moving or low-contrast graphics are less likely to cause ageing of the screen.
- Time displays.
- Teletext: Do not view a static page for a long period of time
- TV/DVD menus: e.g. listings of DVD disc content.
- Pause mode: Do not leave the TV in pause mode for long periods of time, e.g. when watching DVDs or videos.

Important: Once 'shadow image/screen burn' occurs, it will never disappear and is not repairable under warranty.

How do I dispose of this product?

UK: Waste electrical products should not be disposed of with household waste. Please dispose of the product at a designated collection point for recycling of WEEE. For your nearest facilities, please see www.recycle-more.co.uk or ask store for details.

ROI: Waste electrical products should not be disposed of with household waste. Separate disposal facilities exist. Check with your local authority or retailer for recycling advice.

Batteries

- CAUTION: Risk of explosion if the battery is replaced with an incorrect type.
- Do not expose batteries to high temperatures, excessive heat, prolonged sunshine or fire as this may cause leakage, explosion or ignition.
- Observe the correct polarity when inserting batteries.
- Do not use different types of batteries together or mix old and new batteries.
- Dispose of batteries in an environmentally friendly way.
- Certain regions may regulate the disposal of batteries. Please consult your local authority.



CE Statement:

Hereby, Asda declares that this LED TV is in compliance with the essential requirements and other relevant provisions of RED Directive 2014/53/EU.

<http://www.asda.co.uk>

This equipment may be operated in all EU countries.

Wi-Fi max transmitter power:
100 mW at 2,400 GHz – 2,4835 GHz;

TRADEMARKS



The DVB logo is the registered trademark of the Digital Video Broadcasting (DVB) project.



The FREEVIEW text and logos are trademarks of DTV Services LTD. © DTV Services Ltd

SAORVIEW

SAORVIEW is a registered trademark owned by RTÉ.



Manufactured under license from Dolby Laboratories. Dolby, Dolby Audio, and the double-D symbol are trademarks of Dolby Laboratories Licensing Corporation.



For DTS patents, see <http://patents.dts.com>. Manufactured under license from DTS, Inc. (for companies headquartered in the U.S./ Japan/Taiwan) or under license from DTS Licensing Limited (for all other companies). DTS, DTS-HD Master Audio, DTS-HD, Virtual:X, and the DTS-HD logo are registered trademarks or trademarks of DTS, Inc. in the United States and other countries. © 2021 DTS, Inc. ALL RIGHTS RESERVED.



The terms HDMI, HDMI High-Definition Multimedia Interface, HDMI trade dress and the HDMI Logos are trademarks or registered trademarks of HDMI Licensing Administrator, Inc.



The "CI plus" Logo is a trademark of CI Plus LLP.



The Wi-Fi CERTIFIED Logo is a certification mark of the Wi-Fi Alliance.

Microsoft PlayReady™

This product contains technology subject to certain intellectual property rights of Microsoft. Use or distribution of this technology outside of this product is prohibited without the appropriate license(s) from Microsoft.

Content owners use Microsoft PlayReady™ content access technology to protect their intellectual property, including copyrighted content. This device uses PlayReady technology to access PlayReady-protected content and/or WMDRM-protected content. If the device fails to properly enforce restrictions on content usage, content owners may require Microsoft to revoke the device's ability to consume PlayReady-protected content. Revocation should not affect unprotected content or content protected by other content access technologies. Content owners may require you to upgrade PlayReady to access their content. If you decline an upgrade, you will not be able to access content that requires the upgrade.



Instantly recognizable. Instantly reassuring. The Polaroid Classic Border and Polaroid Color Spectrum logos let you know you've purchased a product that exemplifies the best qualities of our brand and that contribute to our rich heritage of quality and innovation.

The Polaroid word and logos are protected trademarks of Polaroid, used under license. Polaroid does not manufacture this product nor provide any product warranties or support.

CONTENTS

Guarentee Information	3
Safety Instructions	4-5
Trademarks	6
Securing to a wall	8
GETTING STARTED	9-19
Connecting External Device - Wired	9-13
Connecting Headphones - Wired	14
Remote Control.....	15-16
TV Control Stick and Input Source Menu.....	17
First Time Installation.....	18-20
USING THE TV	21-35
Television Menu	21
Video & Video, Explained	22-24
Audio & Audio Explained	25-27
TV and TV, Explained	28-29
Setup & Setup, Explained	30-34
Parental & Parental, Explained	35
About	36
DVD Setup	37
DIGITAL TV & FREEVIEW PLAY	38-45
Tuning in Digital Channels	38
Terrestrial	38
Cable	38
Satellite	38
Using Freeview Play	39
Channel Guide	39
Back EPG	40
Quick Buttons.....	40
Freeview Play Button	42
Freeview Play App.....	43
Channel List	44
Information Bar	45
SPECIFICATIONS	46-50
Video Formats	46-47
Audio Formats	48-50
Image Formats	51
TROUBLESHOOTING GUIDE	52-54

SECURING THE TV TO A WALL

Securing the TV to a wall with anti-tip straps

For maximum safety in the home, when using a TV with its stand, anti-tip straps should be fitted. These are available from major retailers & websites and are an easy, inexpensive and effective way of ensuring your TV stays safely upright. Straps are designed to be attached to the rear of the TV and then tethered to the wall or furniture the TV is stood on, these are fitted as follows.

A Using one or both of the top wall-mounting holes and screws fasten one end of the fastening cord/s to the TV. (the screws are already supplied in the wall mounting holes)

B Secure the other end of the fastening cord/s to your wall. (you will need screws/fixings suitable for your wall type - available separately from most DIY stores).

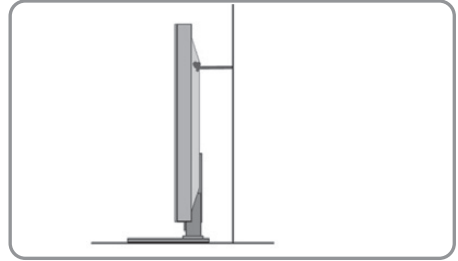
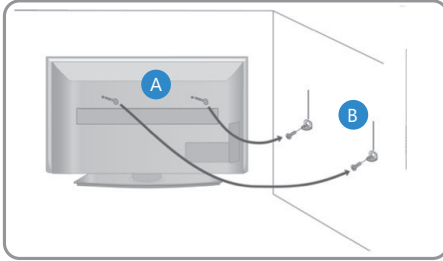

Note: Please ensure that children do not climb on the TV set.

Note: When handling the set do not grip the LCD Panel.

Note: Do not pull the set when mounted on a bracket. If using a moveable bracket, adjust via the bracket and not the set.

The Royal Society for the Prevention of Accidents is urging people to take care with flat-screen televisions.

RoSPA stated in 2010 that "Toddlers are particularly at risk of pulling flat-screen televisions on to themselves. They are unsteady on their feet and are attracted by colourful television images."

The risk is increased as televisions become lighter.

Wall mounting & Viewing Angle

IMPORTANT - Before drilling any holes in the wall ensure you are not drilling where there could be any electrical wires, water or gas pipes.

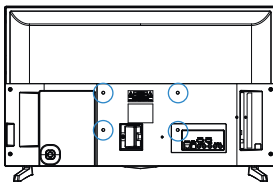

1. Remove the four screws located at the back of the TV set.
2. The wall mount can now be easily attached to the mounting holes, located on the back of the TV, using the same four screws removed.

Note: This diagram to the left is an example of screw positions. Due to model variations, please ensure you check your TV for the exact location of the wall mounting screw positions.

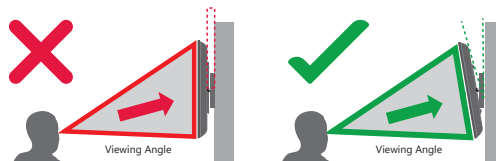

Important: If wall mounting this TV, only use the screws already provided in the wall mounting holes.

Using other screws which are longer could cause irreparable damage to the internal parts. When using a wall bracket, please ensure the screws in the back of the TV set are not over tightened.

CONNECTING EXTERNAL DEVICES - WIRED

Before turning your set on, it is recommended that your external devices are connected before continuing with the first-time installation process. Depending on the source connectivity on your television, follow the guidance below when connecting external devices.

HDMI Connection

For optimum picture quality, we recommend connecting your device to the television using an HDMI cable.

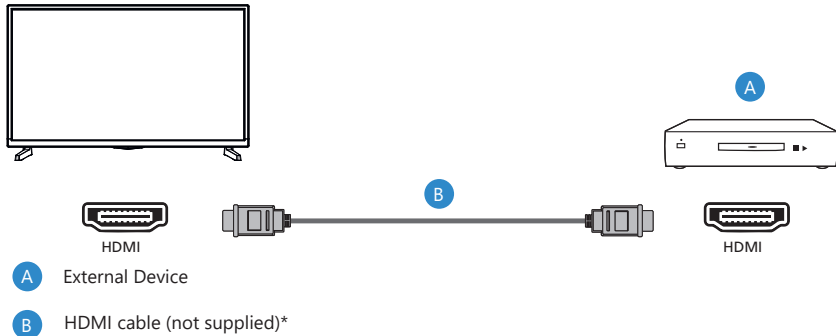

*Be sure to use an authorised HIGH-SPEED HDMI cable bearing the HDMI logo.

HDMI CEC-Compatible Devices

If an HDMI CEC-compatible device (e.g., Blu-ray player, AV receiver) is connected with an HDMI cable, you can operate the device with the television's remote control. We recommend using the HDMI (ARC) connection when used with an AV receiver – please refer to the ARC section of this Operation Manual.

Adjusting HDMI CEC Settings

1. Turn on the connected device.
2. To enable HDMI control, press the **[MENU]** button, then select Setup > HDMI Settings > CEC Control.
3. Activate CEC control on the connected device.

Available options

CEC Function	Allow the TV to control HDMI devices.
ARC	Sends an audio signal via HDMI to a connected audio device (AV receiver, soundbar etc.). This function is available only on HDMI ARC input.
Auto Turn Off	If disabled, the connected device does not turn off automatically when the television is turned off.
Auto Power On	If disabled, the television does not turn on automatically when the connected device is turned on.
Device discovery	Displays the HDMI CEC device list.

Features Available to Compatible CEC Devices

Blu-ray/DVD player

- Automatically turns the television on and switches the input to the connected Blu-ray/DVD player when the Blu-ray/DVD player starts to play.
- Automatically turns the connected Blu-ray/DVD player off when you turn the television off.
- Controls menu operation [**ARROW**] buttons, playback and track selection of the connected Blu-ray/DVD player through the TV's remote control.

AV Receiver

- Automatically turns the connected AV receiver on and switches the sound output from the TV speaker to the audio system when you turn the TV on. This function is only available if you have previously used the AV receiver to output the TV's sound.
- Automatically switches the sound output to the AV receiver by turning the AV receiver on when the TV is turned on.
- Automatically turns the connected AV receiver off when you turn the TV off.
- Adjust the volume and mute functions via the [**VOL +/-**] and [**MUTE**] buttons on your television remote control.

Video Camera

- Automatically turns the TV on and switches the input to the connected video camera when the camera is turned on.
- Automatically turns the connected video camera off when you turn the TV off.
- Controls menu operation [**ARROW**] buttons, playback, e.g. [**PLAY**] button of the connected video camera through the TV's remote control.

Note: Not all devices with HDMI input/output are HDMI CEC compatible. For information about CEC compatibility, refer to the instruction manual of the device.

Refer to "HDMI connection (ARC supported)" section of this manual for information relating to connecting an HDMI (ARC) enabled device.

Composite video Connection

If your external device has composite jacks/sockets, connect them using a composite video/audio cable.

AV Source

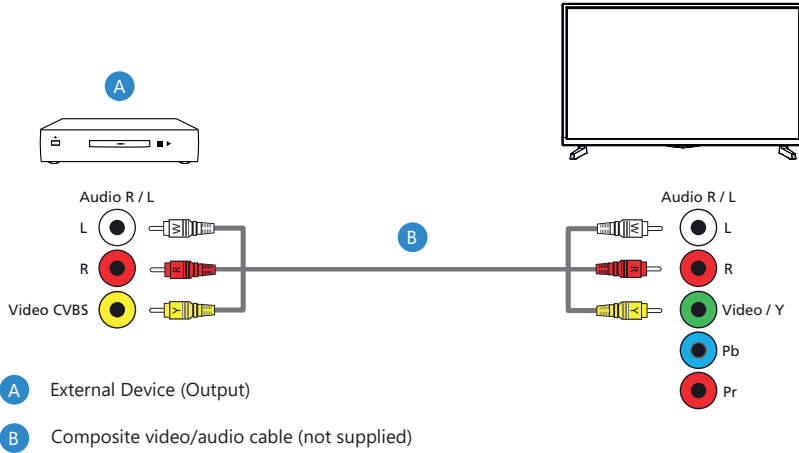

Component video Connection

If your external device has component video jacks/sockets, connect them to the television using a component video cable and an audio Phono cable.

AV Source

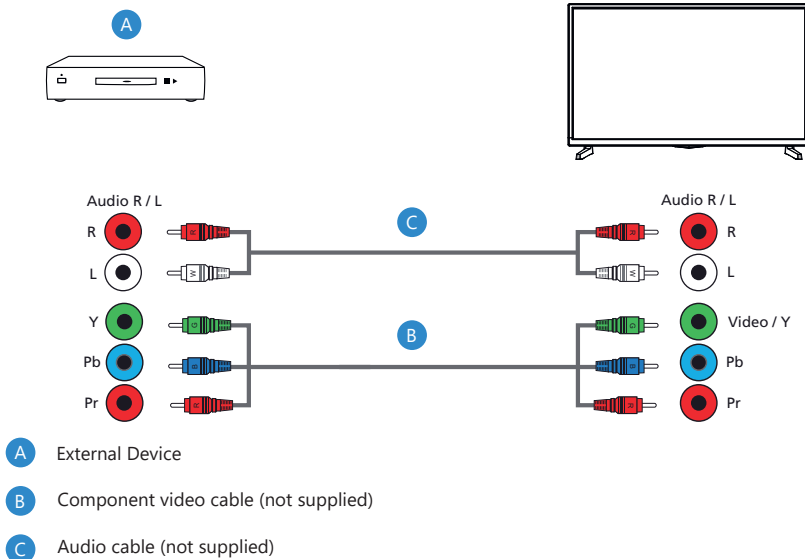

Connecting an External Audio Device

You can connect audio systems such as AV receivers or sound bars to the television. Select a connection method below according to the specifications of the audio system you want to connect.

- Connecting with an HDMI cable. for Details, carefully read *HDMI Connection (ARC supported)*.
- Connecting with a digital optical cable.
- Connecting with an audio cable.

Note: Refer to the instruction manual of the device to be connected.

HDMI Connection (ARC Supported)

Connecting the television and audio system with a HDMI cable. This is the recommended method of connecting an external audio device.

Connect to the television's HDMI input terminal bearing the text "ARC".

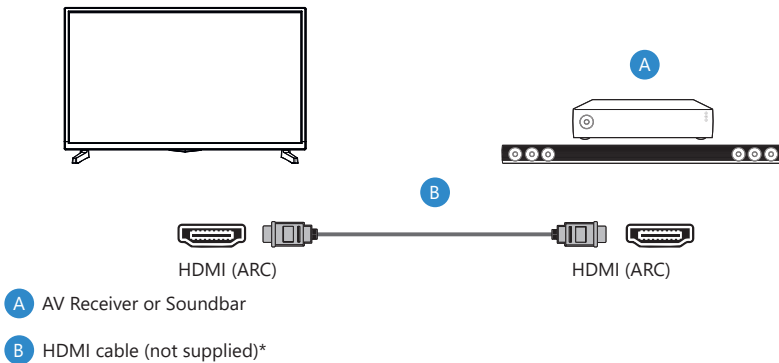

Note: We recommend authorised Premium High-Speed HDMI Cable(s) bearing the HDMI logo.

Ensure that the connected audio device is HDMI ARC compatible.

The ARC output on your television may vary depending on the model.

HDMI CEC must be enabled on your set for this connection to work. To do this press the **[MENU]** button, then select Setup > CEC Control and then enable the CEC Function and ARC.

Control of volume can be achieved via the television remote control (CEC must be turned on).

When ARC is working, the sound from the television speakers will be muted.

You need to configure the Digital Output settings according to your audio system. Press the **[MENU]** button, then select Audio > Digital Output.

If the audio system is not compatible with Dolby Digital or DTS, set Digital Output to PCM.

Digital Audio (Optical)

Connecting your television and audio system with a digital optical cable.

Connect to the audio system digital optical input terminal.

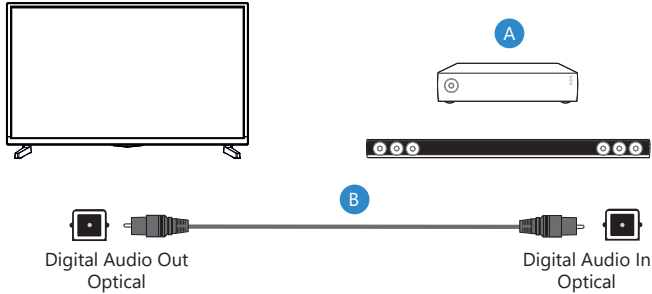

- A AV Receiver or Soundbar
- B Audio Optical cable (not supplied)

If there is no output on the digital optical output, ensure that the digital output is set to PCM. To set, go to: Audio > Digital Output and select PCM.

The digital optical output is always present whatever source is selected.

RCA Analogue Audio Cable

Connect to the audio system's audio input terminal.

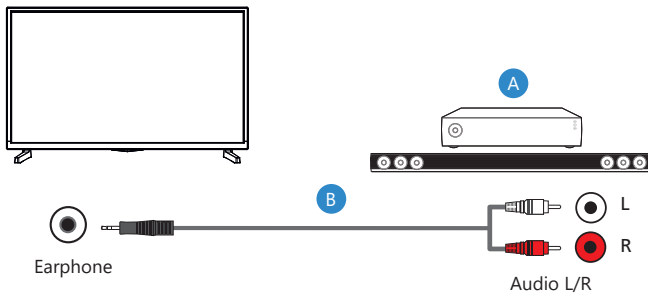

- A AV Receiver or Soundbar
- B Audio cable (not supplied)*

Note: The output audio level is dependent upon the headphone level. The volume level on the connected audio system must be turned up.

Connecting Headphones

You can connect wired headphones to this set.

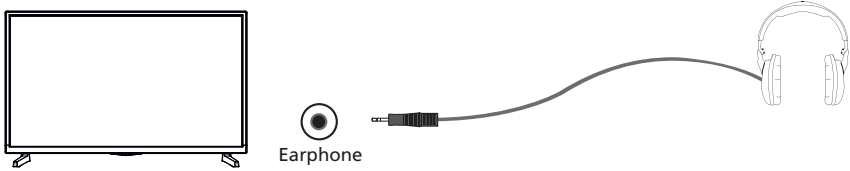

When *wired headphones* are connected to the 3.5mm jack socket on the rear of the set, the internal speakers will cut out. The volume of the sound which comes from the headphones is controlled via the remote control using the [**VOL+**] and [**VOL-**] buttons.

Note: When using headphones, a warning will appear advising not to use excessive volume for long periods of time as this may damage your hearing.

Turning up the headphone volume too high may result in distortion.

REMOTE CONTROL

Remote Control Layout

1. **ON/OFF** - Switch on the TV when in standby or vice versa.
2. **FREEVIEW PLAY** - Access the Freeview Play app.
3. **NUMBER BUTTONS** - 0-9 to select a TV channel directly.
4. **MUTE** - Mute the sound or vice versa.
5. **TV GUIDE** - Opens the 7 day TV guide (digital TV mode).
6. **PICTURE** - Scrolls through picture mode options.
7. **SOUND** - Scrolls through sound mode options.
8. **VOL (+/-)** - To increase/decrease the sound level.
9. **CH (+/-)** - To increase or decrease the channel being watched.
10. **SOURCE** - To display the input/source menu.
11. **MENU** - To display OSD menu.
12. **EXIT** - To exit all menus.
13. **(▲/▼/◀/▶/OK)** - Allows you to navigate the on-screen menus and adjust the system settings to your preference.
14. **BACK** - To go back a previous step.
15. **FAV** - To display favourites menu.
16. **INFO** - Press once for now/next channel information.
17. **TEXT** - To enter/exit Text.
18. **SUBTITLE** - To switch the dialogue at the bottom of the screen (on/off).
19. **TV** - To switch to Digital Channels.
20. **YOUTUBE** - Access the Youtube App.
21. **NETFLIX** - Access the Netflix App.
22. **SMART** - Access the APPS menu.
23. **DVD MENU** - Access the menu of an inserted DVD.
24. **⏮** - To restart the current chapter
25. **⏭** - To advance forward to the next chapter
26. **⏪** - To stop the playback/Eject Disc
27. **REC LIST** - Opens the list of previously recorded items.
28. **⏮** - To play in fast rewind mode
29. **⏭** - To play in fast forward mode
30. **⏸** - To play/pause
31. **GOTO** - To go to a specific chapter.
32. **A-B** - Press once to set point, press a second time to return to point.
33. **ANGLE** - Select different angle of DVD.
34. **REPEAT** - To repeat playback.

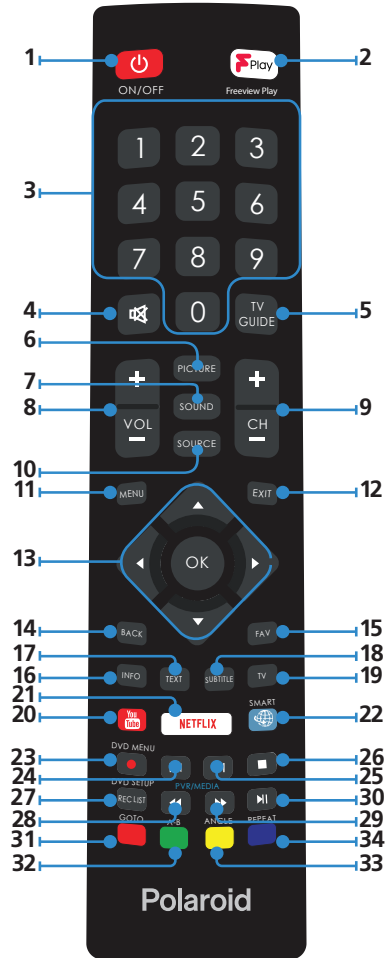

TV CONTROL STICK, DVD BUTTONS AND INPUT SOURCE MENU

For models with the joystick type controller.



TV Control Stick

The TV control stick is located on the back of the TV. The control stick can be used to control many of the TV functions. The shape of the TV's control stick may vary by model.

While TV is in standby mode:

- Press the centre of the control stick once - Power on the TV set

While watching TV:

- RIGHT/LEFT – volume up/volume down
- UP/DOWN – changes channel up/down
- Press the centre of the control stick once – displays the menu
- Press and hold the centre of the control stick – Standby/Power Off

While in menu:

- RIGHT/LEFT/UP/DOWN – navigation of cursor in on-screen menus
- Press the centre of the control stick once – OK/Confirm selected item
- Press and hold the centre of the control stick – back to previous menu

DVD Buttons (Only applied if the TV has an in-built DVD player)

The DVD buttons are located on the side of the TV near the DVD slot

- TOP BUTTON - STOP/EJECT (Hold down for 4 seconds to eject a DVD)
- BOTTOM BUTTON - PLAY/PAUSE

Choosing Mode Input/Source

Use the source menu to switch between input/connections.

A) Using the buttons on the remote control:

1. Press [SOURCE] - The 'source' menu will appear.
2. Press [^] or [v] to select the input you require.
3. Press [OK].

For further information on input/connections please view the 'Connections' pages.

FIRST TIME INSTALLATION

When the set starts up for the first time, it will do so in the first-time installation mode.

To navigate through the options when in the first-time installation mode, use the buttons on your remote control as shown here:

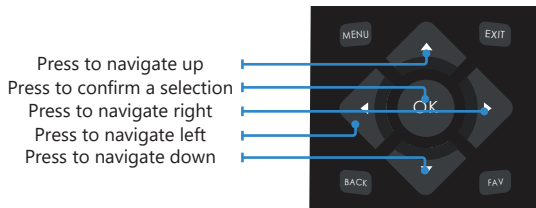

Full First Time Installation

When the set is turned on for the first time it will enter the installation mode as shown here. It is recommended that all steps are completed as shown in the process to ensure correct operation. Use the back button on your remote control to return to the previous screen.

1. When the set first turns on, you will be requested to select your preferred on-screen display language. This will set the language in which the menus and associated information is displayed in. Should you wish to do so, this can be changed later in the Device Preferences menu.

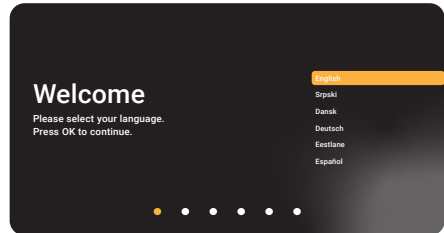

2. Select the correct country in which the set will be used in. This will enable the set to correctly install the functions applicable in the country of use.

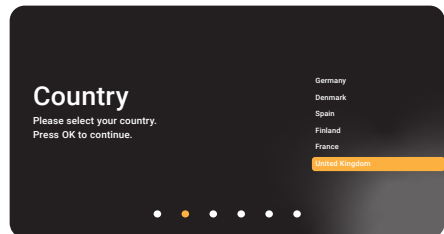

3. A PIN needs to be set to establish parentol controls.

Note: When setting the PIN, you can only set four numbers. Please make a note of this as you will need it to access Parental Settings.

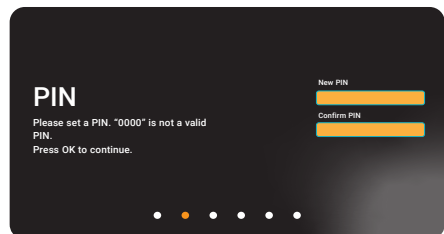

4. Set the Time Zone in which the TV will reside. This may be dependent on the country you selected in step 2.

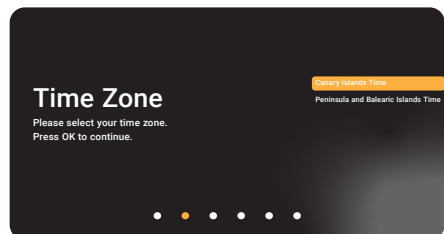

5. You will need to agree to certain information collection for the TV set to operate as intended.

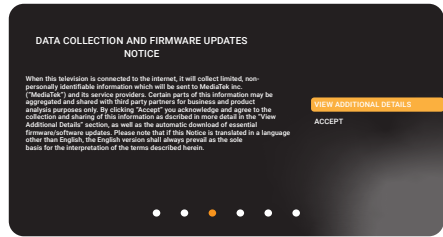

6. You can connect the TV to your broadband router or wireless network in order to take advantage of the Smart functions. If you connect the TV to your router using an Ethernet cable, the Wifi set up will be skipped.

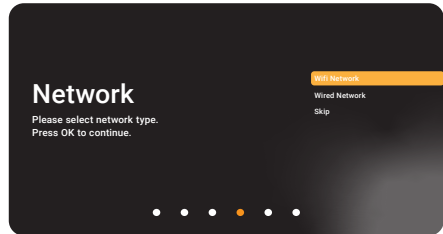

7. If you have a Netflix account, it can be set up on the television here. Once set up and validated, the First Time Installation returns to the next step.

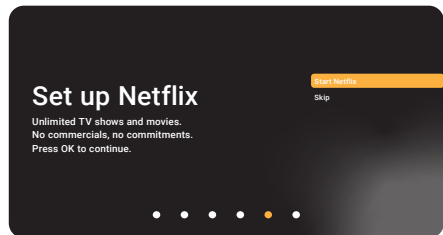

8. For normal use, by default it is set to a power saving mode which reduces the energy used by up to 25% (by reducing the power to the LED/LCD panel). This can be changed in the picture mode settings.

Note: In home mode, the TV will switch off automatically after 4 hours in the event that no buttons are pressed on the TV or remote control.

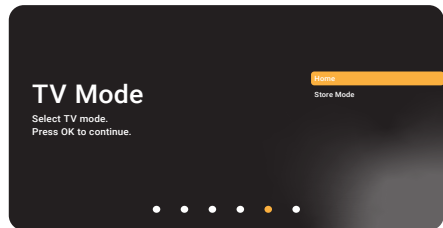

9. Choose to install channels via Antenna, Cable or Satellite. Then Select the next option to scan in channels.

Note: Analogue signals in the United Kingdom have been turned off. Only Digital signals are available.

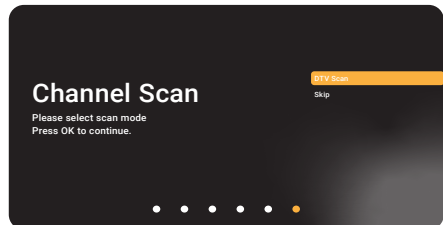

TELEVISION MENU

You can access the settings menu below whilst watching the set in Television mode. To do so, ensure you are on the Live Television source and press the **[MENU]** button on the remote control. This menu opens on the left side of the TV display. Each menu item is described over the following pages.

Video	Opens the options for adjusting the various display settings.
Audio	Opens the options for adjusting the various display settings.
TV	Allows you to configure the channels for live TV.
Setup	Opens the options for adjusting device preferences.
Parental	Opens the options to configure channel and source locks.
About	Opens the system info menu.



Another access menu is available by pressing the Apps button on the remote control. This menu displays on the bottom of the screen and allows easy access to the most common options.

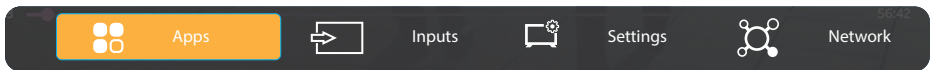

Video



You can change various display options in this menu. To get to this menu, press Menu and select the Video icon. This is an overview. You can see detailed descriptions of items with a * in the "Video, explained" section.

Picture Mode* This menu provides options to modify picture quality.

Backlight Adjust the strength of the LED Backlight.

Brightness Changes the brightness of the picture.

Contrast Changes the range between the brightest and darkest parts of the picture.

Saturation Controls the amount of colour in the picture.

Hue Varies the tint of the picture.

Sharpness Allows for the sharpness of the picture to be adjusted.

Video Delay Adds delay to incoming video signals.

Gamma* Changes the gamma response of the picture.

Colour Temperature* Changes the colour temperature of the picture.

Advanced Video* Options to enhance the viewing experience.

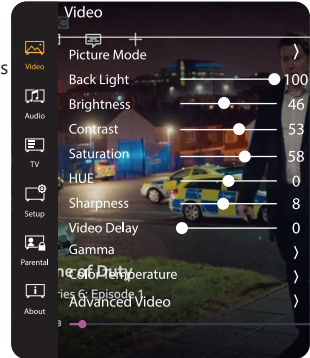

Video, explained

Picture mode.

Options are:

User	For you to set your own preferences.
Sport	Suitable for viewing sports events.
Vivid	Enhances the contrast and brightness.
Standard	For standard use.
Movie	Set for watching movies.
Game	For gamers.
Energy Saving	Best energy performance (on by default).

Gamma

Options are:

Dark	Enhances colours in dark areas.
Middle	Improves mid-range colours.
Bright	Increases brightness of colours.

Colour Temperature

Options are:

Colour Temperature.	Adjusts the color temperature.
options:	User / Cool / Standard / Warm.
Gain:	
Red	Controls red content.
Green	Controls green content.
Blue	Controls blue content.

Advanced Video.

Items with a * are explained further in the section titled "Advanced Video, explained".

Options are:

DNR: Digital Noise Reduction.

Reduces the noise found in some content by using algorithms to average out pixel data.

Options: Off / Low / Medium / Strong / Auto

MPEG NR: MPEG Noise Reduction.

A feature which improves the quality of pictures by reducing the block noise and mosquito noise without compromising the picture resolution.

Options: Off / Low / Medium / Strong

Adaptive Luma Control.

Automatically adjusts the brightness and contrast after analyzing the input signal.

Options: Off / Low / Medium / Strong

Blue Stretch:

When activated, the brightest part of the screen will be leveled down to reduce the saturation.

Options: On / Off

Game Mode:

Turns off certain functions such as motion processing to reduce latency.

Options: On / Off

Super Resolution

Attempts to smooth gradations and decrease noise in the video signal.

Options: On / Off

Local Contrast:

Local contrast divides your TV screen into different "zones" so it can dim the dark parts of the screen without affecting the bright areas.

Options: Off / Low / Medium / High

Colour Tuner:*

Fine tune the TV's colours

11 Point White Balance Correction:*

Adjusts the white balance by adjusting the contrast of the three primary colours.

PC Mode:

Disables certain post processing to attempt a smoother viewing experience for reading text and tracking mouse movements.

Options: On / Off

Note: Depending on television model, some picture mode options may not be available. Some settings will only be stored in the when the Picture Mode is set to User.

Advanced Video, explained

Colour Tuner

Options are:

Enable

Turns the tuner on or off.

When turned to "On", the options available are:

Hue

Fine adjustments of the colour.

Saturation

Fine adjustments of the colour saturation.

Brightness

Fine adjustments of the colour brightness.

Hue, Saturation and Brightness are each controlled by the following:

Red: 0 - 100
Green: 0 - 100
Blue: 0 - 100
Cyan: 0 - 100
Magenta: 0 - 100
Yellow: 0 - 100
Flesh Tone: 0 - 100

Offset

Fine adjustment of the bright colours.

Options are:

Red: 0 - 100
Green: 0 - 100
Blue: 0 - 100

Gain

Fine adjustment of darker colours.

Options are:

Red: 0 - 100
Green: 0 - 100
Blue: 0 - 100

11 Point White Balance Correction

Options are:

Enable

Turns the correction on or off.

When turned to "On", the options available are:

Gain

Options are: 5, 10, 20, 30, 40, 50, 60, 70, 80, 90, 100 (%)

Red: 0 - 100
Green: 0 - 100
Blue: 0 - 100

Audio



You can change various display options in this menu. To get to this menu, press Menu and select the Audio icon. Please note some options require scrolling down to make them visible.

This is an overview. You can see detailed descriptions of items with a * in the “Audio, explained” section.

Balance	Controls the Left and Right balance of the audio.
Sound Style*	Sets the sound mode.
Equalizer Detail*	Fine control of the frequency response.
Digital Output*	Settings for the digital audio output.
Digital Output Delay	Allows the user to adjust the audio setting to synchronise the picture and sound for external speakers connected via a digital audio output.
Auto Volume Control	When “on” is selected, the volume remains at a constant level regardless of the input/source.
Type*	Choose broadcasted audio types.
Visually Impaired*	Controls audio options for accessibility.
Downmix mode	Selects the number of audio output channels between “Stereo” and “Surround”.
Soundtrack	Select which audio channels are being broadcast.
Advanced*	Settings for Dolby Audio™ and DTS™ sound profiles.
TTS*	Controls Text-To-Speech settings.
Dialogue Enhancer	Adjusts the frequency band of the center channel to improve the audibility of dialogues.
Reset to Default	Reset to original parameters.

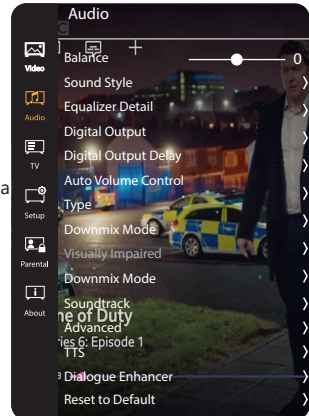

Audio, explained

Sound Style

The sound style configures the equalizer detail based on pre-defined settings.

Options are:

User	For you to set your own preferences.
Standard	Standard, default settings.
Sports	ideal for sports events.
Movie	Enhanced for movie experience.
Music	Best used when listening to radio channels.
News	Tailored for speech.

Equalizer Detail

Fine control of the frequency response. Bands you can adjust are:

120Hz
500Hz
1.5KHz
5.0KHz
10.0KHz

Digital Output

This adjusts the type of encoding for the output of the optical digital output.

Options are:

Auto

Automatically selects from the input source

Bypass

Audio directly comes from the connected device

PCM

PCM encoded stream only

Dolby Audio[®] - Dolby Digital Plus

Dolby Digital Plus signals only

Dolby Audio[®] - Dolby Digital

Dolby Digital signals only

Type

This adjusts the audio type for accessibility.

Options are:

Hearing Impaired

Audio Description

Spoken Subtitles

Audio Description + Spoken Subtitles

TTS (Text-to-Speech)

This adjusts the text-to-speech parameters.

Options are:

Voice On/Off

Volume

Speed

Choose from:

Very Slow, Slow, Normal, Fast, Very Fast

Focus Speed Audio

Choose from: On/Off

Pitch

Verboisity

Visually Impaired

This adjusts the audio options for for those who are visually impaired
Options are:

Speaker On/Off

Headphone On/Off

Volume 0-100

Volume is only activated if Speaker or Headphone is set to "On"

Pan and Fade

Advanced

This adjusts the audio options for the included Dolby Audio and DTS sound profiles.
Options are:

Dolby Audio™ Processing

Turns processing On or Off

Sound Style

Enables Dolby™ engineered sound profiles. Options are:

User / Standard / Sports / Movie / Music / News

DTS™

Turns processing On or Off

Virtual:X™

Enables the DTS Virtual: X™ Tru Bass™ option.

Note: You can only activate either Dolby or DTS, not both at the same time.

TV

You can configure the TV Tuning options whilst in this menu. This is an overview. You can see detailed descriptions of items with a * in the “TV, explained” section.

- Tuner Mode*** Choose which tuner type to use for TV.
- Audio Language** Choose which Audio Language to hear from the broadcasted channel.
- 2nd Audio Language** Second option for Audio Language.
- Channels*** Tune and control Channels.
- Auto Channel Update** Update channels automatically.

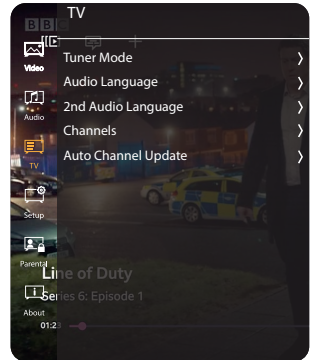

TV, explained

Tuner Mode

Options are:

- Antenna**
To tune into terrestrial broadcast signals.
- Cable**
To tune into Cable broadcast signals.
- Satellite**
To tune into satellite broadcast signals.

Channels

In this menu, you can control various parameters relating to tuned in channels.

Options are:

- Channel Scan**
Select this to begin tuning in channels. Use this to retune your TV manually.
- Manual Service Update**
Select this to begin tuning in additional service information related to channels.
- Single RF Scan**
Select a single channel from the list and press [OK] twice to tune into that specific channel.
- LCN**
Logical Channel Number. When turned on, digital stations will be ordered according to provider preferences.
- Channel Sort**
Options are:
 - Favourite
 - Source Type
 - Name
 - Scrambled
 - Frequency

LCN
Satellite

Channel Skip

Allows you to select channels which can be skipped when browsing through channel selection.

To select a channel for skipping, highlight the desired channel and press [OK] on the remote control.

Channel Skip			
1	Digital	BBC ONE Oxford	<input checked="" type="radio"/>
2	Digital	BBC TWO	<input type="radio"/>
3	Digital	ITV	<input type="radio"/>
4	Digital	Channel 4	<input type="radio"/>
5	Digital	Channel 5	<input type="radio"/>
6	Digital	ITV2	<input type="radio"/>
7	Digital	That's TV	<input type="radio"/>

Channel Swap

Allows you to swap channels between locations. This is only selectable if LCN Channel Sorting is activated.

To swap a channel, first select the channel you want to swap, press [OK] on the remote once, then scroll to the channel you want to swap with, and press [OK] again on the remote control. The channel will swap positions.

Channel Swap			
1	Digital	BBC ONE Oxford	<input checked="" type="radio"/>
2	Digital	BBC TWO	<input type="radio"/>
3	Digital	ITV	<input type="radio"/>
4	Digital	Channel 4	<input type="radio"/>
5	Digital	Channel 5	<input type="radio"/>
6	Digital	ITV2	<input type="radio"/>
7	Digital	That's TV	<input type="radio"/>

Channel Edit

Allows you to edit channel names, or delete it from the channel list. Should you delete the channel accidentally, you will need to retune the Television.

Channel Edit	
Network Name:	Oxon & Bucks
Channel Number:	1
Channel Name:	BBC ONE Oxf...
Frequency	634
Delete	>

Analogue channel fine tune

Allows fine tuning of any analogue signals being broadcast.

Clear Channel List

Clears the tuned in channels. To regain channels, you will need to return the TV using the Channel Scan option in this menu.

SETUP

You can configure the TV's global settings whilst in this menu. This is an overview. You can see detailed descriptions of items with a * in the "Setup, explained" section.

OSD Language Change the language that the TV menus use.

Screen Mode* Make adjustments to how large or small content is displayed.

Blue Mute Switch on or off if a blue screen if no input signal is detected.

HbbTV Settings* Set various options for HbbTV.

DTV Time Setup* Set the time of the TV, Auto Power on/off settings and sleep timers.

CEC Control* Configure how the TV communicates with devices connected via HDMI cables.

Subtitles Select your preferred subtitle language and type.

Teletext Language and region settings (if available).

Common Interface Activate and set up a connected Conditional Access Module (not supplied).

Network* Allows you to connect the set to the internet and take advantage of a wealth of content.

Channel Update Advise when channel update is available, on/off.

USB Upgrade Choose this to update the TV with an available software update via a USB stick.

Reset to Default Resets the TV to original factory settings.

TV Mode Set the TV to either Store Mode or Home Mode.

Internet Update Check Checks the internet for any update to the TV.

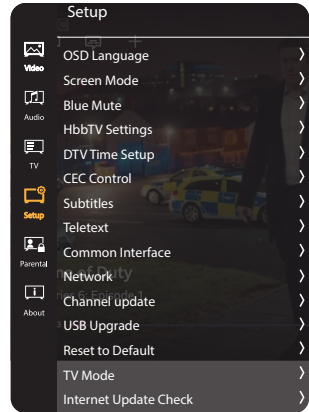

Setup, explained

Screen Mode

Options are:

Auto

Automatically fills the display with the received content.

Normal

Displays content using the full screens area.

Letterbox

Borders on the top and bottom of the screen.

Panorama

Stretches content to display across the screen.

Zoom

Content is zoomed in, cropping edges. Useful if you want to avoid seeing graphics or borders within the received content.

Dot by Dot

1:1 pixel mapping of the received signal.

4:3

Box Ratio.

HbbTV Settings

Options are:

HbbTv Support

Options: On / Off

Do Not Track

Options: On / Off / Default

Cookie Settings

Options: On / Off

Persistent Storage

Options: On / Off

Block Tracking Sites

Options: On / Off

Device ID

Options: On / Off

Reset Device ID

Confirm that you want to reset the device ID for HbbTV

FVP Tou (Terms of Use)

Display the Terms of Use for Freeview Play

Note: For a greater understanding of how HbbTV plays a role in your TV viewing experience, please visit: <https://www.hbbtv.org/overview/>

DTV Time Set Up

Controls the time settings for the TV's internal clock.

Options are:

Time Zone

Choose from GM +/- 0:00:12:00

Time

Options are:

Auto Synchronization:

Auto syncs to the broadcasted time signal. Options are: On / Off

Date

Set the date for the TV.

Time

Set the time for the TV.

Note: Date and Time settings can only be changed if Auto Synchronization is turned **Off**.

Power On Timer

Turn On or Off.

Power On Repeat

Set the frequency by day when the Power on Timer activates.

Timer

Set the time by which the Power On timer is activated.

Power Off Timer

Turn On or Off.

Power Off Repeat

Set the frequency by day when the Power Off Timer activates.

Timer

Controls the amount of time the set will stay powered on without an input signal (remote, button presses) being received.

Duration options are: Never / 4 Hours (default) / 6 hours / 8 Hours

Sleep Timer

Lets you set the sleep timer so the television automatically switches off after a set amount of time.

Off / 10 / 20 / 30 / 40 / 50 / 60 / 90 / 120 minutes can be

Auto Sleep:

Controls the amount of time the set will stay powered on without an input signal (remote, button presses) being received. Duration options are:

Never / 4 Hours (default) / 6 hours / 8 Hours

CEC Control

Controls how the TV communicates with connected devices via HDMI cable.

Options are:

CEC Function

Options: On / Off

ARC (Audio Return Channel)

Options: On / Off

Auto Turn Off

Options: On / Off

Auto power on

Options: On / Off

Device Discovery

Discover new devices connected via HDMI cable.

Network

Controls how the TV connects to the internet.

Options are:

Configuration

Configure various connection options:

Options are:

Internet Connection

Options: On / Off

Interface

Options: Ethernet / Wireless

Wake on LAN

Wakes the TV from Standby when signal via Ethernet when detected.

Options: On / Off

Wake on Wlan

Wakes the TV from Standby when signal via Wireless is detected.

Options: On / Off

Wireless Setting

Choose how you connect to a wireless signal:

Options are:

Scan: Scan for a wireless signal.

Manual: Manually enter details of a wireless router.

Auto: Allows use of connection via WPS.

Information

Displays current connection info.

IP Setting

Configure a wired network.

Connection Test

Tests the current connection.

Preferred IP

Options are:

IPv6 / IPv4

IPv6 Information

Displays IPv6 configuration information.

IPv6 Configuration IP

Allows configuration of IPv6 settings.

WiFi Direct

Set up options for WiFi Direct connection sharing.

Applications

Set up options for applications

Options are:

DLNA

Turn On / Off

DMR

Turn On / Off

PARENTAL



You can configure the TV's Parental settings whilst in this menu. This is an overview. You can see detailed descriptions of items with a * in the "Parental, explained" section.

Broadcasting System Lock Controls if the Channel and Program Block options are enabled. Options: On / Off.

Channel Block* Select channels that cannot be accessed without a PIN.

Program Block* Select which programs can be viewed when using the Age Rating system.

Input Skip* Allows control over which input sources can be skipped.

Input Block* Block one or several inputs with access controlled via PIN.

Change Password Update the password/PIN which control the Parental Settings.

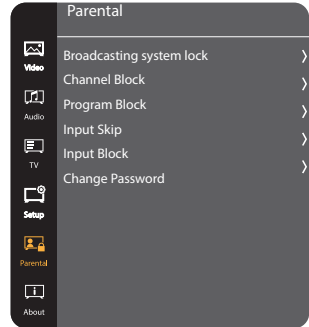

Note: If you have activated any settings and leave the menu, you will need to enter your PIN to enter the menu again.

Parental, explained

Channel Block

Controls how the TV blocks channels. Use this system to enable specific channel blocking. To view a channel, the user will need to enter the PIN number.

Program Block

Controls how the TV blocks specific programs using the Age system. You can set which age appropriate programs are viewable.

Note: The setting of Program Block relating to digital television transmissions rely on the transmitted channel and programme containing age restriction information. If this is not present, your television will not be able to block the content.

Input Skip

Select which inputs are to be skipped from the Input Menu. When an input is selected to be skipped, it will be not be visible in the list of inputs.

Input Block

Select which inputs are to be blocked from the Input Menu. When an input is selected to be blocked, it will be be visible in the list of inputs but require a PIN to access it.

ABOUT



You can view the TV's About information whilst in this menu.

- Netflix** View various information relating to the Netflix Licence.
- Help Information** Allows you to use the online manual. To use this, you will need to be connected to the internet.
- Version Info** Version info for the TVs software. Used for diagnosis.
- License Info** View license information and control user data collection.
- System Information** Update the password/PIN which controld the Parental Settings.
- TV Name** Change the TV name.

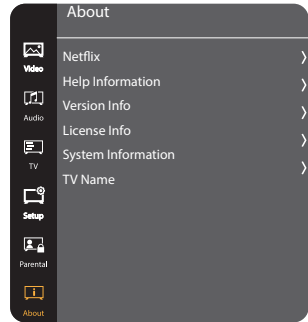

DVD SETUP

Applies to models with built-in DVD players only



To enter this menu please ensure the TV is in DVD source & press [DVD SETUP]

If you wish to make changes to any of the default settings, use the scroll ▲▼▶◀ buttons. To confirm any settings press [OK] button. To exit this menu at anytime, press [DVD SETUP] button.

TV Display - Choose from the following options:

4:3 Pan scan	PS traditional picture format, this is often used with older film formats
4:3 Letter box	LB Traditional picture which has been adapted for widescreen
Wide	16:9 Widescreen picture format

Speaker Setup - Choose from the following options:

LT/RT	Converts from multi-channel sound to mono
Stereo	Converts from multi-channel sound to stereo

Dual Mono - Choose from the following options:

Stereo	Outputs 2 channels of sound both left and right
Mono L	Outputs left side sound
Mono R	Outputs right side sound
Mix Mono	Outputs a single channel of sound but mixed between right and left

Dynamic Range - This is the difference between the quietest and loudest sounds. This setting only works with DVD discs recorded in Dolby Digital

Full	Set this to listen with the range recorded on the disc
3/4	Set this to listen with a range equivalent to a normal television
1/2	Set this to listen with a smaller difference between the maximum and minimum volume
1/4	Set this to listen with a smaller difference between the maximum and minimum volume
Off	Set dynamic range to off

TV Type - Choose from the following options:

PAL	For TVs produced in the UK, Europe, Asia, Australia etc
Multi	For both NTSC and PAL
NTSC	For TVs produced in North America, Japan etc

Default - Choose from the following options:

Reset	Resets all options in the 'DVD setup' menu back to the default settings
-------	---

Note: This TV/DVD player is pre-set to play Region 2 DVD's.

DIGITAL TELEVISION, FREEVIEW AND FREEVIEW PLAY

To watch television programmes via Antenna, Cable or Satellite, press the **[SOURCE]** button and select "DTV". You can also enter the digital television mode by pressing the **[TV]** button on the remote control.

Should your set not be tuned into a digital signal, follow the instructions as below:

Tuning in Digital Channels

It is possible to tune into either terrestrial, cable or satellite digital television signals on your television set. To do this, follow the instructions given below for each type of signal input. Only one tuning type can be selected.

Terrestrial

Before tuning terrestrial channels, ensure the television is in TV mode:

1. Press the **[MENU]** button, then select TV > Tuner Mode.
2. Select option Antenna.
3. To start automatic channel scan press the **[MENU]** button, then select TV > Channels > Channel Scan.

After tuning into Freeview, you may be presented with a choice of regions; this is dependent upon your location and the number of transmissions received. Normally there will only be one transmitter:

- Region 1 Country
- Region 2 Transmitter Location
- Region 3 Local News variation

Cable

Receiving cable digital broadcast;

1. Before tuning cable channels, ensure the television is in cable mode:
2. Press the **[MENU]** button, then select TV > Tuner Mode.
3. Select option Cable.
4. To start automatic channel scan, press the **[MENU]** button, then select TV > Channels > Channel Scan.

Satellite

Before tuning satellite channels, ensure the television is in satellite mode:

1. Press the **[MENU]** button, then select TV > Tuner Mode.
2. Select option Operator Only if you want to tune one of satellites preferred in your country.
3. Select option All Satellites to get possibility to tune any satellite.
4. To start automatic channel scan, press the **[MENU]** button, then select TV > Channels > Satellite Re-scan.
5. Choose the Satellite you wish to tune.
6. Select Scan and press **[OK]**.

Using Freeview Play

Freeview Play enables you to watch live television as well as having access to catch up television services and playback from the start of a live programme.

Note: To use Freeview Play your set needs to be connected to the internet and tuned into a reliable and consistent Freeview signal.

Freeview Play is only available in the United Kingdom.

To tune in your set, refer to the *Tuning in Digital Channels* section on page 63.

Channel Guide

While using Freeview Play, the Electronic Programme Guide (EPG) is available while in the Live Television mode. It provides information about forthcoming programmes. You can view the start and end time of all programmes and on all channels for the next 7 days. To enter the EPG, press the **[GUIDE]** button on your remote control. Press the **[EXIT]** button to leave programme guide.

When the EPG is entered, a screen like the one below will appear. This will show a live preview of the programme being received in the top left-hand corner and a synopsis this on the right. This synopsis will change as you navigate around the guide with the **[ARROW]** buttons on the remote control.

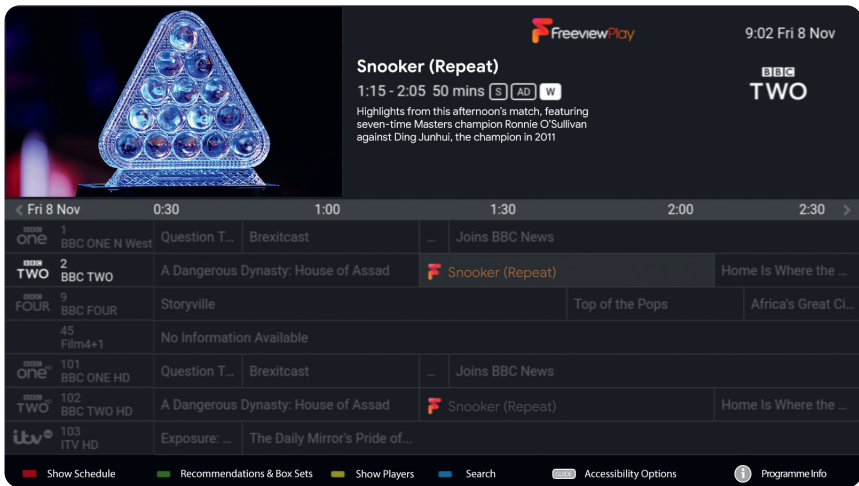

In the middle of the display is the programme listing, which is shown in time order, half hour segments being shown at the top and channel name on the left. If you would like to quickly scan through the channels, press the **[CH+]** or **[CH-]** buttons to quickly move up or down through the listings. Using the **[RIGHT]** button will move forward in time, using the **[LEFT]** button will move back in time.

Back EPG

When moving backwards through the EPG, the display will change to show the programmes which have been previously recorded on the on-demand players for the channel shown. Recorded and available programmes will be indicated by the Freeview Play logo appearing next to them as shown in the picture below. Greyed out programmes are not available on catch up.

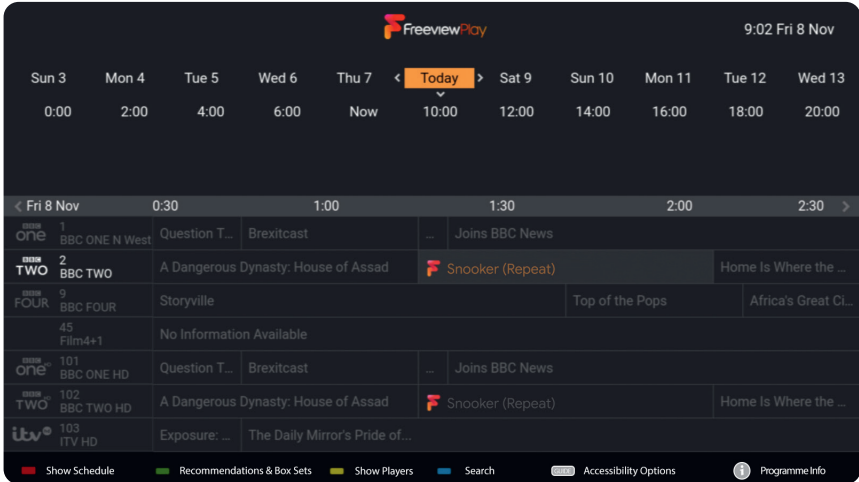

When a programme has been selected, the preview window and synopsis change to show the programme details. The date is below the preview window.

Note: For full functionality of the EPG, a reliable and consistent connection to the internet is required.

Without internet, back EPG will not work, channel preview will not appear, programme synopsis will change to a basic view, channel icons will not be present and catch up services will not be available.

Quick Buttons

While in the EPG, various functions can be accessed quickly by pressing the coloured buttons at the bottom of the remote control. These are detailed as described below.

[RED] – Goes to the Schedule List

While in the schedule list you can go backwards and forwards in time (7 days forwards and 7 days backwards) to select the programme which you would like to watch. If the Freeview Play logo is present, the programme can be played back when selected using the **[ARROW]** buttons and **[OK]** is pressed.

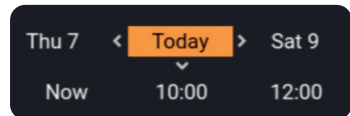

You can also select the day and time of the schedule list view by entering the rows at the top of the screen and selecting the day and time range.

[GREEN] – Recommendations & Box Sets

Freeview Play recommendations can be viewed by pressing the **[GREEN]** button on the remote control. This screen allows you to choose the programme to watch directly or select from a number of genres. Select the programme to watch using the **[ARROW]** keys on the remote control and then press **[OK]** to start playback.

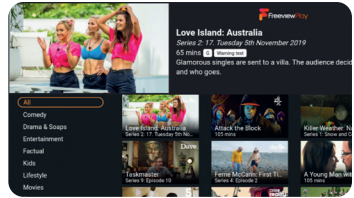

[YELLOW] – Show Players

When the **[YELLOW]** button is pressed on the remote control while in the EPG or in recommendations, the set will allow access to the back EPG and the various Freeview Play on-demand applications. The 'Catch Up' menu allows you to access available programmes, from the last 7 days, that you may have missed. The 'Catch Up' menu will show programmes, by day, in the order that they were broadcast (descending in time order).

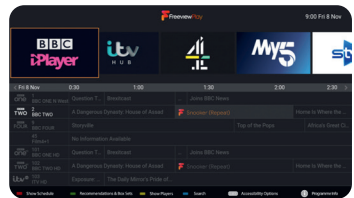

To navigate through this page, use the **[ARROW]** buttons on the remote control and then press **[OK]** to either play back the selected programme or go into the chosen on-demand player.

While playing back a programme, or in one of the on-demand players, pressing **[BACK]** or **[EXIT]** on the remote control will take you back to the 'Catch Up' menu. Pressing **[BACK]** or **[EXIT]** again takes you out of the programme guide and back to standard television.

Note: Catch Up is only available on Freeview Play. On-demand players may require you to log in.

[BLUE] – Search

You can use the powerful search function to look for a recorded programme by its name. Use the on-screen keyboard to enter the name, or part of the name of the programme which you would like to view and then select from the list which appears to the right of the keyboard.

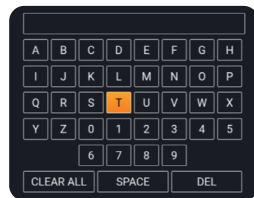

When the required name is shown on the right-hand side, it can be selected to bring up the list of programmes with that title. Select one of the streams to playback using the **[ARROW]** buttons on the remote control and **[OK]** to start the playback.

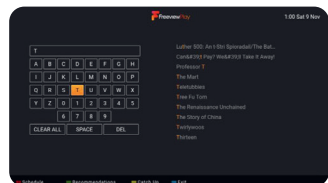

Freeview Play Button

If the **[FREEVIEW PLAY]** button is pressed on the remote control, the set will display the Freeview Mini Guide.



Programmes on now are displayed for all channels. Select one of these using the **[ARROW]** buttons on the remote control and **[OK]** to change to this channel and view the programme.

While on the selected channel, you can also press one of the coloured buttons on the remote control.

Should there be a "swirl" symbol next to the programme name, this means that you can playback the program from the start.



[RED] – View Programme List

Press the **[RED]** button to enter the view programme list for the channel you are on. This will show both future and past programmes which can be selected by pressing the **[LEFT]** or **[RIGHT]** arrow buttons on the remote control and the **[OK]** button to view.

If the **[INFO]** button is pressed while on the selected programme, then an information screen is displayed.

While in the view programme list, the **[RED]** button can be pressed to return to the On TV Now option.

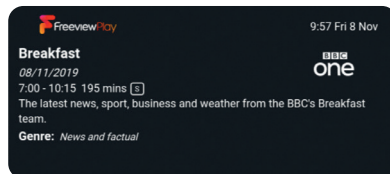

[GREEN] - Recommendations

Press the **[GREEN]** button to view recommendations for the channel that you have selected.

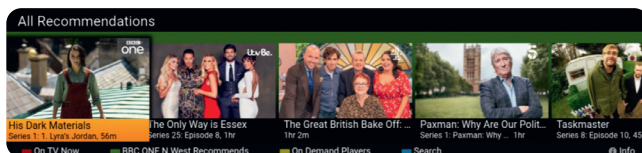

If the **[GREEN]** button is pressed here, all recommendations for all channels will be shown.

[YELLOW] – On Demand Players

Press the **[YELLOW]** button to enter the on-demand players.

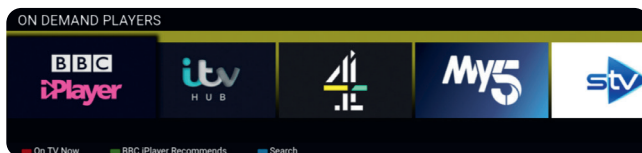

[BLUE] - Search

Press the **[BLUE]** button to search for a television programme. This is the same as the search function on the main EPG page.

Freeview Play App

The Freeview Play app can be accessed a number of ways on your television set:

- From the Programme Guide press the **[YELLOW]** button and then select the Explore Freeview Play app.
- From the Home Page, select the Explore Freeview Play app.
- While in Freeview, select channel 100.
- Press the **[FREEVIEW PLAY]** button followed by the **[YELLOW]** button. Select the Freeview Play app from the on-demand players.

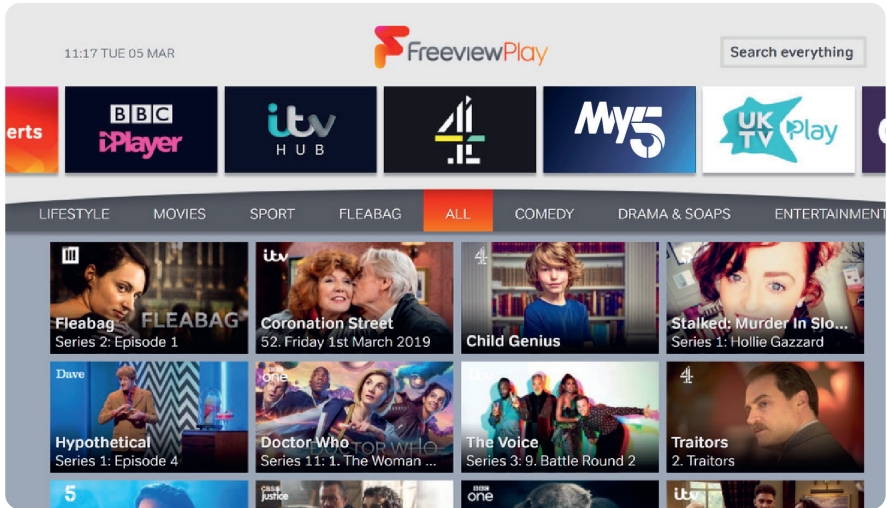

When in the Freeview Play application, it is possible to search for a programme by name. Choose the “Search everything” option and then use the on-screen keyboard to type in the programme name. As you type, selections will appear. Select one of these options and press the **[OK]** button to start playback.

Freeview Play brings together live television viewing with “catch up” television services from broadcasters such as BBC, ITV, Channel 4 and Channel 5. The Freeview Play Explore app features a carousel of genres to select from when searching for programmes, such as sport, comedy, dramas and soaps, etc. Content is made up from recommendations of the major broadcasters and offers an alternative means of searching.

Note: To use the full functionality of Freeview Play your set must be connected to the internet.

Some apps require additional registration, this is a simple process and it will inform you of the correct website to visit to complete the registration.

Areas receiving Saorview transmissions will not support Freeview Play or Freeview Play services.

Channel List

Use the channel list to quickly go to the channel you want to watch. Use the **[GREEN]** and **[RED]** buttons to navigate up and down the list.

Filter List

Press the **[YELLOW]** button to get options to sort or filter channels and search channel by its number or name. When you select Type, it is possible to restrict the Channel list to various types of channels such as Radio, Free, Analogue, etc.

When selecting Find, you can search for a channel name by its name by entering the name you are looking for via the on-screen keyboard.

Favourites List

Press the **[BLUE]** button to open Favourites list. A list of your favourite channels will be shown here. No channels will appear unless you have added them to the list.

Adding a Favourite Channel

To add a favourite channel, go to the live digital television channel you would like to add to your favourites list, press the **[MENU]** button and then the **[UP ARROW]** button. The "Add to Favourites" icon should be highlighted, press **[OK]**. The channel is now added to your favourites list.

Adding a Favourite Channel

To modify your list of channels:

1. Press the SOURCE button and select television.
2. Press the MENU button and go to Settings > Channel > Channels.

You can choose one of menu items related to editing of channel list:

Channel Remote

Allows you to choose channels, which will be skipped when pressing **[CH+ / CH-]** buttons on the skip.

Channel Sort

Allows you to swap position of two channels between each other.

Channel Move

Allows you to move selected channel to new position.

Channel Edit

Allows you to delete channels from the channel list.

Information Bar

When the [**INFO**] button is pressed on the remote control, the information bar will appear at the top of the screen.

If the [**INFO**] button is pressed again, the information bar will change to show further detail.

This shows a large amount of information on the channel currently being received, this includes the following:

- Channel selected
- Program being transmitted
- Time progress bar
- Program start and end time
- Time of day
- Description of the program
- Subtitles available
- Audio description available
- Program genre

SPECIFICATIONS

USB

Supported Video Formats

Video Codec	Container	Data Rate	Profile	Resolution
XviD	MP4 (.mp4, .mov)	40 Mbps	N/A	1080P @ 60fps 3840 by 2160 @ 30fps
	DivX (.divx)			
	AVI (.avi)			
	MKV (.mkv)			
	ASF (.asf)			
Sorenson H.263	FLV (.flv)	40 Mbps	N/A	1080P @ 60fps 3840 by 2160 @ 30fps
	AVI (.avi)			
	SWF (.swf)			
H.263	MP4 (.mp4, .mov)	40 Mbps	N/A	1080P @ 60fps
	3GPP (.3gpp, .3gp)			
	AVI (.avi)			
	MKV (.mkv)			
H.264	FLV (.flv)	62.5 Mbps	. Main Profile . High Profile @ Level 4.2	1080P @ 60fps 3840 by 2160 @ 30fps
	MP4 (.mp4, .mov)			
	3GPP (.3gpp, .3gp)			
	MPEG transport stream (.ts, .trp, .tp)			
	ASF (.asf)			
	WMV (.wmv)			
	AVI (.avi)			
	MKV (.mkv)			
MPEG4	MPEG program stream (.MPG, .MPEG)	40 Mbps	. Simple Profile . Advanced Simple Profile@Level 5. .GMC is not supported	1080P @ 60fps 3840 by 2160 @ 30fps
	MP4 (.mp4, .mov)			
	3GPP (.3gpp, .3gp)			
	AVI (.avi)			
	MKV (.mkv)			
	ASF (.asf)			
HEVC/H.265	MP4(.mp4,.mov)	50 Mbps	. Main(8bits)/ . Main10(10bits) Profile, High Tier@ Level 4.1	2048x1088 @ 60fps
	3GPP(.3gpp, .3gp)			
	MPEG transport stream(.ts, .trp, .tp)			
	MKV(.mkv)			
SHVC	MP4 (.mp4, .mov)	50 Mbps	.Main(8bits) .Main10 (10bits) Profile, High Tier@Level 4.1	2048x1088 @ 60 fps + 1280x720 @ 60 fps
	3GPP (.3gpp, .3gp)			
	MPEG transport stream (.ts, .trp, .tp)			
	MKV (.mkv)			
MVC	MPEG transport stream (.ts, .trp, .tp)	62.5 Mbps	N/A	1080P @ 30 fps

[Continued Next Page](#)

Supported Video Formats (continued)

Video Codec	Container	Data Rate	Profile	Resolution
AVS	MPEG transport stream (.ts, .trp, .tp)	60 Mbps	. Jizhun profile @ Level 6.0	1080P @ 60 fps
AVS+	MPEG transport stream (.ts, .trp, .tp)	60 Mbps	Broadcasting profile@Level 6.0.1.08.60	1080P @ 60 fps
MPEG1/2	MPEG program stream (.DAT, .VOB, .MPG, .MPEG)	MPEG1 40 Mbps MPEG2 80 Mbps	MP@HL	1080P @ 60 fps
	MPEG transport stream (.ts, .trp, .tp)			
	MP4 (.mp4, .mov)			
	3GPP (.3gpp, .3gp)			
	AVI (.avi)			
	MKV (.mkv)			
Motion JPEG	ASF (.asf)	10 Mbps	N/A	640x480 @ 30 fps
	AVI (.avi)			
	3GPP (.3gpp, .3gp)			
	MP4 (.mp4, .mov)			
	MKV (.mkv)			
ASF (.asf)				
VP8	MKV (.mkv)	50 Mbps	N/A	1080P @ 60 fps
	WebM (.webm)			
VP9	MKV (.mkv)	30 Mbps	. Profile0/2	2048x1088 @ 60 fps
	WebM (.webm)			

Supported Audio Formats

Audio Codec	Container	Sample Rate	Bit Rate	Channel
MPEG1/2 Layer1	MOVIE:	16KHz ~ 48KHz	32 Kbps ~ 448 Kbps	Up to 2
	AVI (.avi)			
	ASF (.asf)			
	DivX (.divx)			
	Matroska (.mkv)			
MPEG transport stream (.ts, .trp, .tp)				
MPEG1/2 Layer2	MOVIE:	16KHz ~ 48KHz	8Kbps ~ 384Kbps	Up to 2
	AVI (.avi)			
	ASF (.asf)			
	DivX (.divx)			
	Matroska (.mkv)			
MPEG transport stream (.ts, .trp, .tp)				
MPEG1/2/2.5 Layer3	MOVIE:	8KHz~48KHz	8Kbps ~ 320Kbps	Up to 2
	AVI (.avi)			
	ASF (.asf)			
	DivX (.divx)			
	Matroska (.mkv)			
	3GPP (.3gpp, .3gp)			
	MP4 (.mp4, .mov)			
MPEG transport stream (.ts, .trp, .tp)				
AC3	MOVIE:	32KHz, 44.1KHz, 48KHz	32Kbps ~ 640Kbps	Up to 5.1
	AVI (.avi)			
	Matroska (.mkv)			
	DivX (.divx)			
	3GPP (.3gpp, .3gp)			
	MP4 (.mp4, .mov)			
	MPEG transport stream (.ts, .trp, .tp)			
	MPEG program stream (.DAT, .VOB, .MPG, .MPEG)			
	RM (.rm, .rmvb)			
	MUSIC:			
	AC3: (.ac3)			
	MP4 (.m4a)			

Continued Next Page

Supported Audio Formats (continued)

Audio Codec	Container	Sample Rate	Bit Rate	Channel
EAC3	MOVIE:	32KHz, 44.1KHz, 48KHz	32 Kbps ~ 6 Mbps	Up to 5.1
	3GPP (.3gpp, .3gp)			
	MP4 (.mp4, .mov, .m4a)			
	MPEG transport stream (.ts, .trp, .tp)			
	MPEG program stream (.DAT, .VOB, .MPG, .MPEG)			
	MUSIC:			
	EAC3 (.ec3)			
MP4 (.m4a)				
VORBIS	MOVIE:	Up to 48KHz	N/A	Up to 2
	Matroska (.mkv)			
	WebM (.webm)			
	3GPP (.3gpp, .3gp)			
	MP4 (.mp4, .mov)			
	MUSIC:			
	MP4 (.m4a)			
OGG (.ogg)				
LPCM	MOVIE:	8KHz ~ 48KHz	64 Kbps ~ 1.5 Mbps	Mono, Stereo, 5.1
	AVI (.avi)			
	Matroska (.mkv)			
	3GPP (.3gpp, .3gp)			
	MP4 (.mp4, .mov)			
	MPEG transport stream (.ts, .trp, .tp)			
	MPEG program stream (.DAT, .VOB, .MPG, .MP EG)			
	MUSIC:			
	WAV (.wav)			
MP4 (.m4a)				
G711 A/ MP4 (.m4a) mu-law	MOVIE:	8KHz	64 Kbps	1
	AVI (.avi)			
	Matroska (.mkv)			
	3GPP (.3gpp, .3gp)			
	MP4 (.mp4, .mov)			
	MUSIC:			
	WAV (.wav)			
MP4 (.m4a)				

Continued Next Page

Supported Audio Formats (continued)

Audio Codec	Container	Sample Rate	Bit Rate	Channel
IMA-A DPCM MS-A DPCM	MOVIE:	8KHz ~ 48KHz	32 Kbps ~ 384K bps	Up to 2
	AVI (.avi)			
	Matroska (.mkv)			
	3GPP (.3gpp, .3gp)			
	MP4 (.mp4, .mov)			
	MUSIC:			
	WAV (.wav)			
MP4 (.m4a)				
DTS	MOVIE:	Up to 48KHz	< 1.5 Mbps	Up to 5.1
	MPEG transport stream (.ts, .trp, .tp)			
	MPEG program stream (.DAT, .VOB, .MPG, .MPEG)			
	Matroska (.mkv)			

Supported Image Formats

Image	Photo	Resolution Recommended (width x height)
JPEG	Base-line	15360x8640 (1920x8 x 1080x8)
	Progressive	1024x768
PNG	Non-interlace	9600x6400
	Interlaced	1200x800
BMP		9600x6400
MPO	Base-line	15360x8640 (1920x8 x 1080x8)
	Progressive	1024x768
GIF		6400x4800

TROUBLESHOOTING GUIDE

If a full restart of the TV is required

If you have trouble, such as the picture not displaying on the screen or the remote control not working, reset the television with the following procedure.

If an external USB device is connected to the TV, disconnect the USB device from the TV before resetting.

Power Reset

Restart the TV with the remote control.

Press and hold the power button on the remote control for about 5 seconds until the [**Power off**] message is displayed. Confirm this by pressing OK button and the TV will turn off.

Unplug the AC power cord (mains lead).

If the problem persists after step 1, unplug the TV power cord (mains lead) from the electrical outlet and wait for 2 minutes. Then plug the power cord (mains lead) back into the electrical outlet.

Note: Your personal settings and data will not be lost after the TV restarts.

Factory Data Reset

If the problem persists after a power reset, try a factory data reset.

Note: Performing a factory reset will delete all of the TV's data and settings (such as Wi-Fi and wired network setting information).

Press the [**MENU**] button, then select Settings > Setup > Reset to Default.

After the factory reset process completes successfully, your television will proceed into the first time installation mode.

No colour/Dark picture/Colour is not correct/Picture is too bright

You can adjust colour tone, brightness and picture quality on your TV from the Picture menu in Settings.

Press the [**MENU**] button, then select the Video option.

In this menu you can make manual picture adjustments.

Distorted picture/The screen flickers

You can check the connection and position of the antenna (aerial) and external devices.

Check the antenna aerial/cable connection.

Keep the antenna aerial/cable away from other connecting cables.

When installing an optional device, leave some space between the device and the TV.

Make sure that the antenna (aerial) is connected using a high quality 75-ohm coaxial cable.

Check the troubleshooting guide for the connected device.

There are icons and text on the edges of the screen

In this case, the TV might be in store demo mode. Try exiting store mode.

Press the [**MENU**] button on the remote control and select Setup > TV mode > Change to Home Mode.

Some channels are blank

The channel is for scrambled/subscription service only. Subscribe to a pay TV service.

The channel is used only for data (no picture or sound).

Contact the broadcaster for transmission details.

No sound but good picture

Check the volume control.

Press  or [VOL+] button to cancel muting.

Remove any headphones.

The TV cannot connect to the Internet/Network

If the Wi-Fi network does not connect or disconnects, try the following.

Press the [MENU] button and check that the following setting is enabled. Setup > Network > Internet Connection.

Check the installation location of the TV and Wi-Fi router. Signal condition may be affected by the following:

Other Wi-Fi devices, microwaves, fluorescent lights, etc. that may be located nearby.

There are floors or walls between the Wi-Fi router and television.

Turn the Wi-Fi router off and then on again.

If the network name (SSID) of the Wi-Fi router to which you want to connect is not displayed, select Add new network to enter a network name (SSID).

If the problem is not resolved even after the procedures above or if you cannot connect even with a wired network, check the status of the network connection.

Do I need an aerial signal?

For full functionality of your TV set equipped with Freeview Play you will require an aerial connected to the set with an adequate and reliable signal.

TV can connect to the Internet, but not to certain apps and services

The date and time settings of this TV may be incorrect. Depending on certain apps and services, you may not be able to connect to these if the time is incorrect.

Press the [MENU] button, then select Setup > DTV Time Set Up > Auto Synchronization > Use network-provided time to automatically adjust the time through the network.

Check that the LAN cable or AC power cord (mains lead) of the router/modem has been connected properly.

Try using apps later. The app content provider server may be out of service.

Troubleshooting

The remote control does not operate.

Check if the TV is working properly.

Press the power button on the television to determine if the problem is with the remote control or not.

Check if the remote control is working properly.

Point the remote control at the remote control sensor located at the front of the television.

Keep the remote control sensor area clear from obstacles.

Fluorescent light can interfere with remote control operation; try turning off any fluorescent light.

Check that the orientation of each battery matches the positive (+) and negative (-) symbols in the battery compartment.

Battery power may be low. Remove the remote control cover and replace the batteries with new ones.

I cannot set the picture levels while on apps

This is because the application sets the picture levels.

I cannot access Freeview Play

To enable Freeview Play to operate correctly, you must have the set tuned in and set up in the UK and installed as country setting UK. In addition, it needs to be connected to the internet.

Why am I not able to use letters in my PIN?

Your PIN is a quick code used for accessing some of the higher functions of your set. This only contains numbers so that they can be entered using your remote control keypad.

Can I set parental controls?

Parental controls are possible when receiving digital television channels (should this service be provided by the broadcaster).

Parental control within apps is determined by the functionality of the app. For details on this you will need to go into the app settings.

What do I do if my apps do not work?

First check that your set is connected to the internet, if it is, ensure that the internet connection is consistent and reliable. If this does not resolve the issue, remove the mains supply from the set and turn back on a few minutes later.

Press the **[MENU]** button, then select Setup> Reset to Default.



Polaroid



Distributed by: Asda Stores Ltd., Leeds LS11 5AD
©2022, All Rights Reserved.

This product is manufactured, distributed and sold by Asda Stores Limited.
The Polaroid word and logos are protected trademarks of Polaroid, used under license.
Polaroid does not manufacture this product nor provide any product warranties or support.
Assembled in Poland.

Copyright © 2022 All rights reserved.

Disclaimer

Product features, specifications and appearance are subject to change without notice.