

George.
home

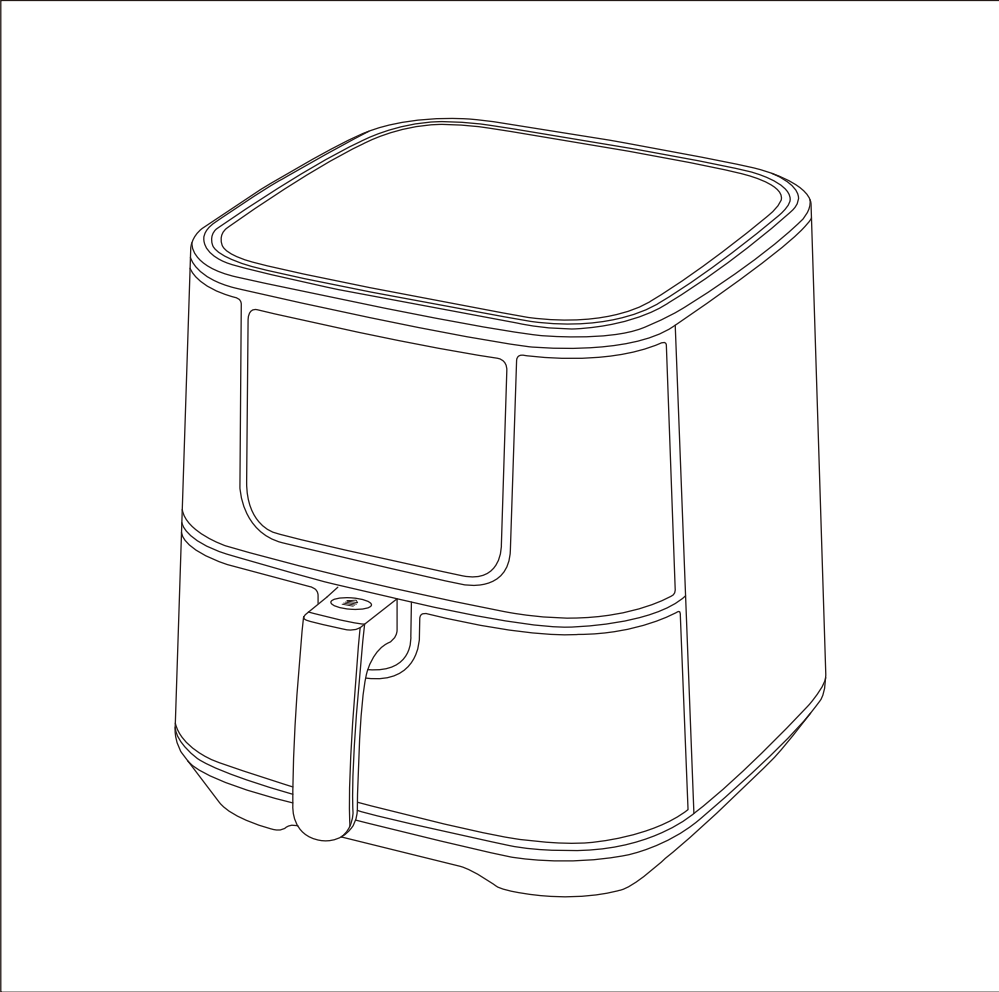

GHAFN1621SS3Q

GH 6.2L digital air fryer w/SS deco

User Guide

220-240V~50/60Hz, 1600-1800W

IMPORTANT: RETAIN FOR FUTURE REFERENCE

About this guide

We're here to help you get the most from your digital air fryer, so please keep hold of this manual for future use.

WARNINGS:

THIS PRODUCT WAS DESIGNED AND MANUFACTURED TO MEET STRICT QUALITY AND SAFETY STANDARDS. THERE ARE, HOWEVER, SOME OPERATIONAL PRECAUTIONS YOU SHOULD BE AWARE OF.



CAUTION. HOT SURFACE. THIS SURFACE IS LIABLE TO GET HOT DURING USE. DO NOT TOUCH THE MAIN FRYER BODY. ONLY USE THE HANDLE AND CONTROL PANEL.

1. Read all warnings & instructions in this manual to ensure you get the best out of your product.
2. For household use only. Only use this appliance for its intended purpose as described in this manual. This appliance is only suitable for domestic use and is not designed for commercial use.
3. This appliance can be used by children aged from 8 years and above and persons with reduced physical, sensory or mental capabilities or lack of experience and knowledge if they have been given supervision or instruction concerning use of the appliance in a safe way and understand the hazards involved. Children shall not play with the appliance. Cleaning and user maintenance shall not be made by children unless they are older than 8 and supervised.
4. Keep the appliance and its cord out of reach of children less than 8 years.
5. ASDA does not recommend allowing children to operate this appliance.
6. Before connecting the digital air fryer to the power, check the voltage shown on the appliance corresponds with the voltage for the mains supply of the country you are in. If it doesn't, contact your local store.

7. Please don't dismantle. If a fault occurs, have the digital air fryer inspected in a qualified repair shop or return to us at ASDA.
8. Remove all packaging prior to use. Inspect the product for any damage before use. If damage is found, notify ASDA to exchange the product.
9. If the supply cord is damaged, it must be replaced by the manufacturer, its service agent or similarly qualified persons in order to avoid hazard.
10. Do not use if the appliance, cord or plug is damaged.
11. The cord shouldn't hang over the edge of a table or counter, or touch a hot surface.
12. To avoid fire, electric shock, or injury, never immerse the digital air fryer, cord, or plug in water or liquid. Do not use with wet hands.
13. Always place on a firm, level, heat-resistant surface, out of reach of children.
14. Do not place the appliance against a wall or other appliances. Leave at least 10cm (4") free space at the back, top and sides of the appliance. Do not place anything on top of the appliance.
15. Do not place the appliance on or near a hot gas or electric stove, electric cooking plates or in a heated oven.
16. Do not place near flammable materials such as tablecloths, curtains or blinds.
17. Keep appliance out of direct sunlight.
18. The appliance is not intended to be operated by means of an external timer or separate remote-control system.
19. Do not leave the digital air fryer unattended when in use.
20. Regarding the instructions for cleaning surfaces in contact with food, please refer to chapter "Cleaning the digital air fryer".
21. Always turn off the digital air fryer and unplug at the mains socket after use.
22. Allow the appliance to cool down for at least 30 minutes before cleaning or storing.

23. During air frying, hot steam is released from the heat air vent. Keep your hands and face at a safe distance from the heat air vent. Also take care when removing the basket drawer from the fryer as steam will be released.
24. Surfaces of the digital air fryer will become hot when in use. Take care to only touch the handle or control panel.
25. Do not cover the air inlet or outlet areas whilst the appliance is operating.
26. Only put food to be fried into the basket drawer. Do not place any food into the main body of the appliance.
27. Do not place oil or cooking fat in the basket drawer as this may cause a fire hazard.
28. Do not place liquid in the basket drawer.
29. Do not overfill the basket drawer.
30. After removing the basket drawer from the appliance, leave to rest on a heat resistant surface for 30 seconds before removing the grill.
31. Do not move the appliance whilst it's operating.
32. Always ensure the basket drawer is fully closed before operating.
33. Environmental information: If at anytime in the future you should need to dispose of this product, please note that, in the UK, waste electrical products/batteries should not be disposed of with household waste.

What's in the box

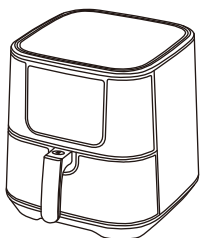

Digital air fryer

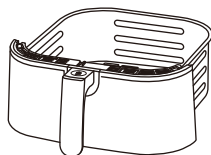

Basket drawer

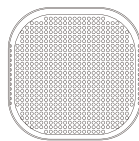

Grill



User guide

Features

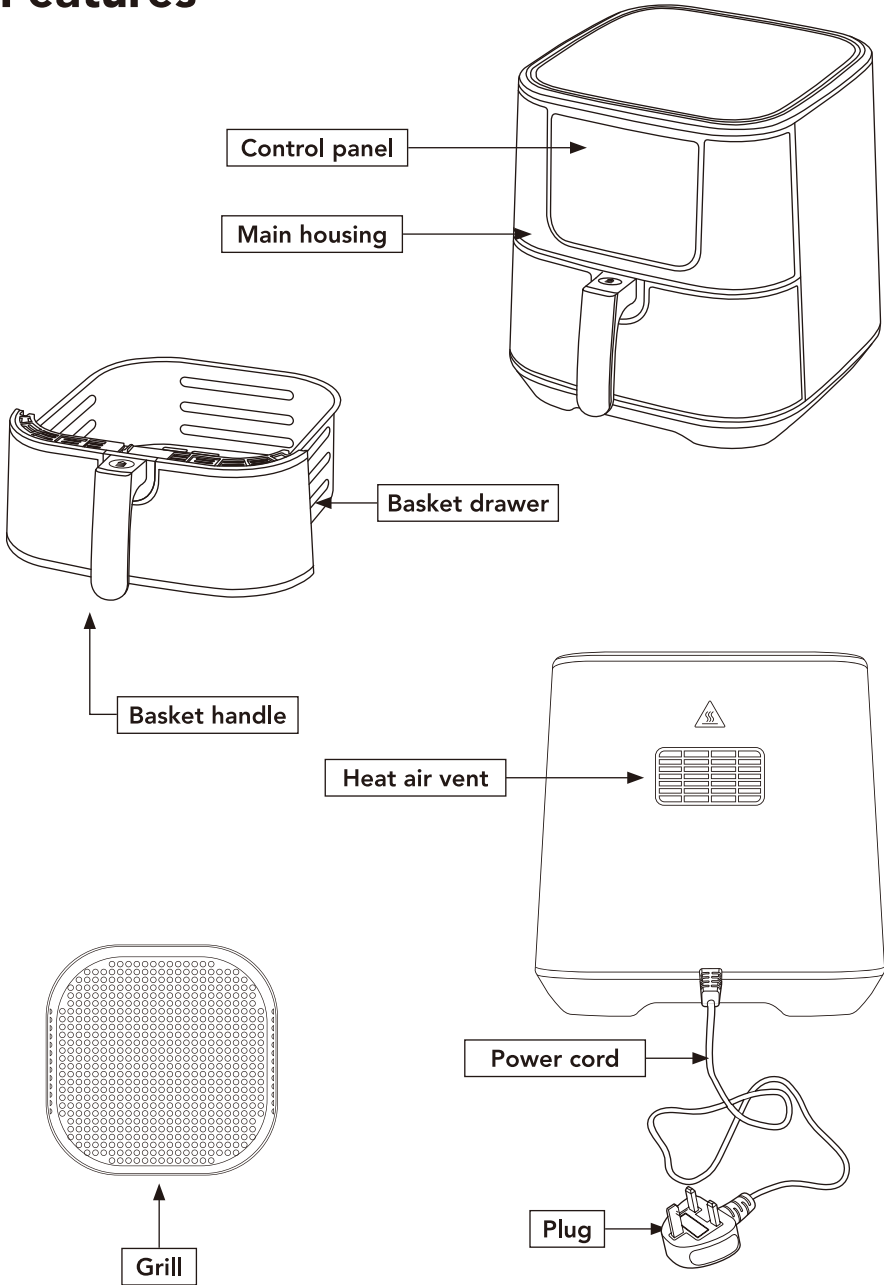

Before you start

Remove all packaging. It is advised to rinse the basket drawer and grill before first use in warm, soapy water and dry thoroughly. Place the appliance on a flat, stable, heat-proof surface. Leave at least 10cm (4") free space at the back, top and sides of the appliance. During first use there might be a slight odour. This is normal for a new cooking appliance.

Prepping hints and tips

Below are some hints and tips to get the most out of your digital air fryer.

1. Smaller ingredients usually require less cooking time than larger ingredients.
2. Shaking food part way through the cooking time optimises the end result and ensures the food is cooked evenly.
3. Coat potatoes in oil before frying to get a crispy outer.
4. For homemade chips, peel and slice potatoes (thinner chips will give crispier results). Rinse in cold water to remove excess starch to prevent the chips from sticking together. Pat dry with a clean tea towel or paper towel, and coat with oil before placing into the basket.
5. Any food that can be cooked in a conventional oven can be cooked in the digital air fryer.
6. Avoid cooking food with a high fat content, such as sausages. The fat can cause white smoke if the residue burns onto the basket drawer or grill during the cooking process.
7. The maximum capacity is 1200g, 800g for chips.
8. You can use the digital air fryer to reheat food. Simply set the temperature to 150°C for up to 10 minutes.
9. If you prefer a crispier finish, try increasing the temperature during the last 5-10 minutes of cooking time. Always check the food is fully cooked through.
10. If cooking from cold, it is best to add an additional 3 minutes to the cooking time to allow the fryer to heat up.
11. The grill and basket drawer have a non-stick coating so only use nylon or silicone utensils to move the food.

Loading the digital air fryer

1. Slot the plug into the electrical socket and turn the power on.
2. Remove the basket drawer from the main housing (1).
3. Ensure the grill is inside the basket drawer and pushed all the way to the bottom (2).

NOTE: Never use the digital air fryer without the grill in the basket drawer. □

4. Place the food you wish to fry on top of the grill in the basket drawer and slide the basket drawer back into the main housing (3), ensuring it 'CLICKS' into place.

NOTE: When you place the basket drawer into the main housing you will hear a 'BEEP' and the whole control panel will illuminate.

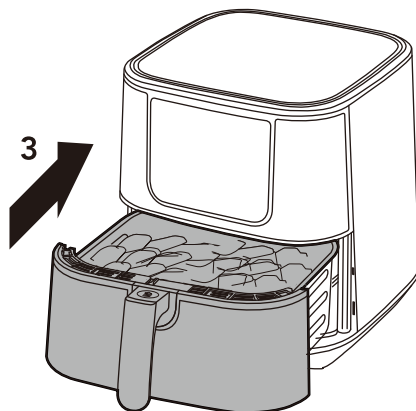
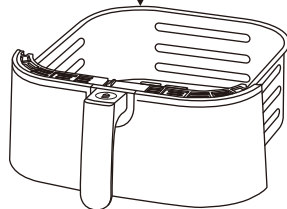
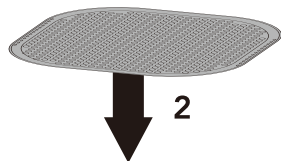
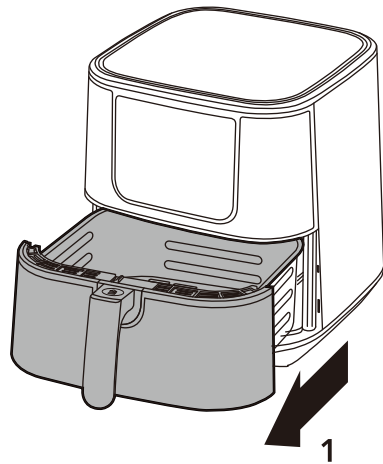

The control panel

Below lists all the features on the control panel which will be referred to in the cooking sections of this manual.

1. Power on/off. Start/pause.
2. Fan in use
3. Heating in operation
4. Time decrease
5. Time icon
6. Time increase
7. Preset cooking icons
8. Temperature increase
9. Temperature icon
10. Temperature decrease
11. Preset menu
12. Number display

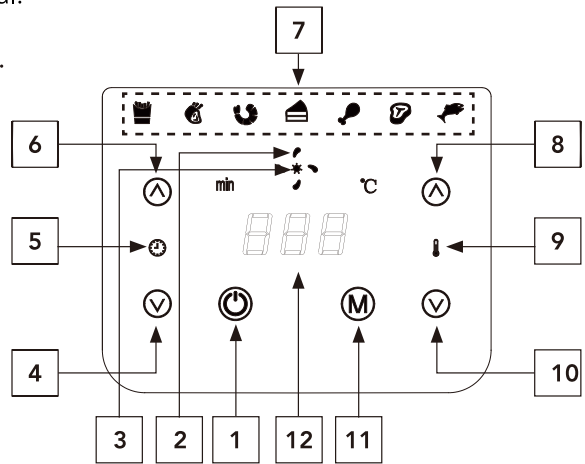

Cooking using the default setting

1. Prepare the food you wish to fry and place it on the grill in the basket drawer. Close the basket drawer fully until you hear it 'CLICK'.

NOTE: The control panel will only work if the basket drawer is fully closed. Always ensure the grill is in place before placing food into the basket drawer. Avoid overfilling the basket drawer.

2. Press the power button on the control panel; you will hear a 'BEEP'. 
3. Once switched on, the control panel will display its default setting of 180°C for 15 minutes. The temperature and time will flash alternately on the display.

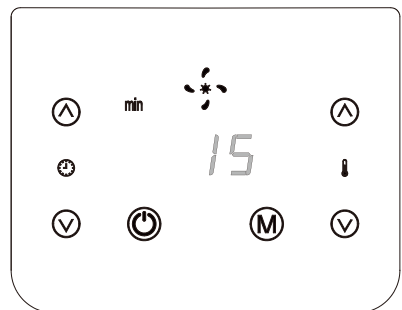
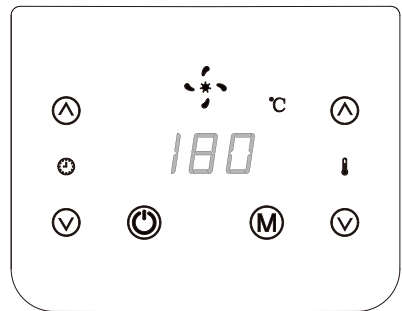

4. To start cooking using the default settings, simply press the "⏻" button once. The fryer will start cooking. The control panel will alternate in displaying the temperature and time.



NOTE: Some foods require shaking part way through the cooking time. Simply open the basket drawer and shake. The digital air fryer will automatically switch off and on when the basket drawer has been opened or closed. If the food hasn't cooked in the given time, simply put the food back into the fryer and set the fryer for a few more minutes.

Larger quantities of food may require a longer cooking time and shaking more often throughout cooking.

To turn off the fryer completely, press the start/pause button "⏻". The fan will run for a few seconds and then the fryer will switch off.

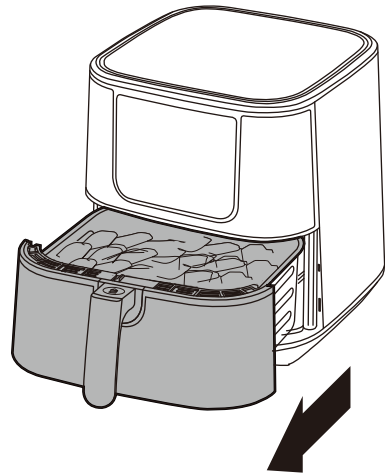





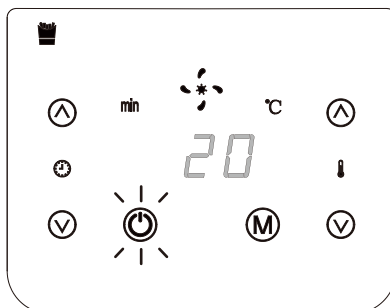

Using the preset cooking programs

The digital air fryer has 7 preset cooking programs.

1. Ensure the basket drawer is fully closed, press the power button on the control panel and you will hear a 'BEEP'.
2. Press the " M " button on the control panel. This will display the first preset cooking icon. Simply keep pressing the button until you reach the desired preset program.
3. To start the cooking, press the " ⏻ " button. The fryer will start cooking at the preset time and temperature for the specific program.
4. Once the cooking is finished, the fryer will 'BEEP' before shutting down completely. Remove and serve the food.



Below is a guide to the preset menu.

Preset menu	Food type	Icon	Time (mins)	Temperature (°C)
1	Thin frozen chips		18	200
2	Pork chop		25	175
3	Shell fish		8	165
4	Muffin		30	155
5	Drumstick		20	180
6	Steak		12	200
7	Whole fish		10	175

Adjusting the temperature and time

Being able to adjust the temperature and/or time will allow more control over the cooking process. The settings can be adjusted before or during cooking.

1. To adjust the temperature simply press the temperature increase or decrease buttons on the control panel. The temperature range is from 80°C to 200°C and moves in increments of 10°C.
2. To adjust the cooking time simply press the time increase or decrease buttons on the control panel. The time range is from 1 minute to 60 minutes and moves in increments of 1 minute.

Below is a guide to the preset menu.

Food type	Min to max quantity (g)	Time (mins)	Temperature (°C)	Helpful tip
Thin frozen chips	300 - 500	18 - 20	200	Shake halfway through the cooking time. For best results, shake every 5 mins during the cooking process. Pre-programmed as a preset menu.
Thick frozen chips	300 - 500	20 - 25	200	
Beef burger	100 - 500	10 - 15	180	Turn over halfway through cooking time.
Frozen breadcrumb food e.g. breaded nuggets	100 - 500	8 - 10	180	Shake halfway through cooking time.
Chicken breast	100 - 500	15 - 20	180	Turn over halfway through cooking time.
Chicken drumsticks	100 - 500	25 - 30	180	Turn over halfway through cooking time. Pre-programmed as a preset menu.
Frozen fish fingers	100 - 500	6 - 10	200	
Pork chops	100 - 500	10 - 15	180	Turn over halfway through cooking time. Pre-programmed as a preset menu.
Sausage roll	100 - 500	13 - 15	200	
Spring roll	100 - 500	8 - 10	200	Shake halfway through cooking time.
Cake	400	20 - 25	160	Use a metal baking tin (to help conduct the heat evenly into the cake).

Cleaning the digital air fryer

Make sure the digital air fryer is disconnected from the power and is completely cool before cleaning.

1. Clean the basket drawer and grill in warm, soapy water. Do not use harsh, abrasive cleaners, only a soft sponge. Soak the items for 10 minutes prior to wiping if there is stubborn dirt or grease.
2. Wipe the outside and inside of the fryer with a damp cloth and dry with a soft cloth.
3. Ensure all parts are thoroughly dry and assemble the fryer before storing. Store in a clean, dry place out of reach of children.
4. The grill and basket drawer can be washed in a dishwasher on the top rack on a normal cycle; please note this may affect the surface appearance over time.

Troubleshooting

Problem	What to do
The fryer does not work.	<ol style="list-style-type: none">1. Ensure it is plugged in securely. Check the basket drawer is fully inserted into the main housing.2. Check the mains fuse has not been tripped (if it has, reset the fuse).3. See if another appliance works when plugged into the same socket (if it doesn't, the socket might be faulty).4. Replace the fuse.5. Ensure the time is not set to '0'.6. Ensure the basket drawer is fully closed.
The food is not cooked properly.	<ol style="list-style-type: none">1. Try putting smaller quantities in the basket drawer.2. Increase the cooking temperature.3. Extend the cooking time.
The food is unevenly cooked.	<ol style="list-style-type: none">1. Part way through cooking, shake or turn over the food.
The food isn't crispy.	<ol style="list-style-type: none">1. Before cooking, coat / brush the food with a little oil.
The basket drawer can't be closed.	<ol style="list-style-type: none">1. The basket drawer might be too full. Remove some of the food and try again.2. Make sure the grill is fitted into the basket drawer properly. It should be flush with the bottom of the basket drawer.
The fryer is smoking in use.	<ol style="list-style-type: none">1. Steam will be released during cooking as a normal part of the process.2. Some foods with higher fat content can create smoke during the cooking process. Drain any excess liquid from the basket drawer, and clean the product thoroughly before next use.

100 DAY SATISFACTION GUARANTEE

If for any reason you're not completely satisfied with our product, return it within 100 days with your proof of purchase, and we'll give you an exchange or a refund.

UK Mainland stores only.

Excludes franchises.

The guarantee excludes flat pack furniture, which can't be returned if it has been partly or fully assembled unless faulty or mis-described.

Also excludes mattresses, which can't be returned for hygiene reasons once used, unless faulty or mis-described.

Need something else?

www.GEORGE.com

We have a wide range of accessories and other products that can be ordered direct to your door.

For PDF copy of this manual please scan QR code and search for model number



ASDA
technical support
0333 600 7700

Customer services information

If you require further information, spare parts or advice regarding your product, or if you are experiencing any problems, please contact customer services at the telephone number or address shown opposite. N.B. When calling or writing please quote the product name.

Call

0800 952 0101

Write

ASDA, Leeds, LS11 5AD.

Product name: **GHAFN1621SS3Q**
GH 6.2L digital air fryer w/SS deco

Product site code: **15A.06.23.075**



To qualify for the 2 year warranty the appliance must have been used according to the manufacturer's instructions. For example kettles should have been regularly de-scaled.

If your appliance stops working or develops a fault then return it to your nearest store and we will happily replace or refund the item, with exception of the below exclusions:

EXCLUSIONS

ASDA shall not be liable to replace goods under the terms of the warranty where:

1. The fault has been caused or is attributable to accidental use, misuse, negligent use or use contrary to the user manual's recommendations or where the fault has been caused by power surges or damage caused in transit.
2. The appliance has been used on a voltage supply other than that described on the product rating label.
3. Repairs have been attempted by persons other than our service staff (or authorised dealer).
4. Where the appliance has been used for hire purposes or non-domestic use.
5. ASDA are not liable to carry out any type of servicing work, under the warranty.

This warranty does not confer any rights other than those expressly set out above and does not cover any claims for consequential loss or damage. This warranty is offered as an additional benefit and does not affect your statutory rights as a consumer.

If for any reason this item is replaced during the 2 year warranty period, the warranty on the new item will be calculated from original purchase date. It is vital to retain your original proof of purchase to indicate the date of initial purchase.

Copyright

© 2023 ASDA Stores Limited.
All other trademarks appearing herein are the property of their representative owners. Specifications are subject to change without notice.

Manufactured for:
ASDA, Leeds LS11 5AD/
ASDA, Antrim BT41 4GY.

Disposal

This symbol on the product or in the instructions means that your electrical and electronic equipment should be disposed at the end of its life separately from your household waste. There are separate collection systems for recycling in the UK. For more information, please contact the local authority or your retailer where you purchased the product.

